

BUKTI KORESPONDENSI ARTIKEL JURNAL NASIONAL BEREPUTASI

Judul Artikel : Academic Motivation as a Mediator of Social Support and Achievement Orientation: Case of Muslim High School in Indonesia

Jurnal : Psikis : Jurnal Psikologi Islami
(<https://jurnal.radenfatah.ac.id/index.php/psikis/index>)
Volume 10 No.1, 2024, Hal. 175-185

DOI : <https://doi.org/10.19109/psikis.v10i1.23328>

Sinta : Sinta 2 (<https://sinta.kemdikbud.go.id/journals/profile/4315>)

E-ISSN / P-ISSN : 2549-6468 / 2502-728X

Jumlah Penulis : 1

Penulis ke : 1 dari 1 Penulis

Penulis : Tugimin Supriyadi

Korespondensi : Tugimin Supriyadi
(email: tugimin.supriyadi@dsn.ubharajaya.ac.id)

No	Perihal	Tanggal
1	Bukti konfirmasi submit dan artikel yang disubmit	11-06-2024
2	Bukti konfirmasi review tim editorial	12-06-2024
3	Bukti konfirmasi hasil review oleh reviewer	18-06-2024
4	Bukti konfirmasi hasil reviewer, respon kepada reviewer, dan artikel yang disubmit	18-06-2024
5	Bukti konfirmasi submit artikel revisi dan artikel yang diresubmit	24-06-2024
6	Bukti Accepted	25-06-2024
7	Bukti Konfirmasi Published	25-06-2024

No	Perihal	Tanggal
1	Bukti konfirmasi submit dan artikel yang disubmit	11-06-2024



← Back to Submissions

23328 / **Supriyadi** / Academic Motivation as a Mediator of Social Support and Achievem

Library

Workflow	Publication
Submission	Review Copyediting Production

Submission Files 🔍 Search

▶ 70533 Article Submit.docx	June 11, 2024	Article Text
--	---------------	--------------

[Download All Files](#)

Pre-Review Discussions Add discussion

Name	From	Last Reply	Replies	Closed
Comments for the Editor	21-05-200011-06-2024 02:50 PM	-	0	<input type="checkbox"/>
Review Report	sitidini12-06-2024 02:39 AM	21-05-200016-06-2024 03:21 AM	1	<input type="checkbox"/>
Information For Author	sitidini12-06-2024 03:15 AM	21-05-200016-06-2024 03:23 AM	1	<input type="checkbox"/>

Comments for the Editor



Participants

Siti Dini Fakhriya (sitidini)

Tugimin Supriyadi (21-05-2000)

Messages

Note	From
Dear Board of Editors Team, please allow me to submit a journal article to be published, I am ready to follow the review process, thank you	21-05-200011-06-2024 02:50 PM

[Add Message](#)

Review Report





Participants

Sarah Afifah (sarahafifahuin)

Siti Dini Fakhriya (sitidini)

Tugimin Supriyadi (21-05-2000)

Messages

Note	From
<p>Dear Authors, We ask for your willingness to revise according to the comments. Please mark revised items with colored highlights and send back the revised results on June 14, 2024. Please log into the journal web site, The web site is https://jurnal.radenfatah.ac.id/index.php/psikis Plagiarism check 24%</p> <p> Turnitin Academic Motivation Mediates Between Social Support and Achievement Orientation_ Case of Muslim High School In Indonesia.pdf</p> <p> Article+Submit.docx</p>	<p>sitidini12-06-2024 02:39 AM</p>
<p>▶ Dear Board of Editors Here we send the revised results, thank you</p> <p> 1 Review Editor Article+Submit.docx</p>	<p>21-05-200016-06-2024 03:21 AM</p>

[Add Message](#)



Information For Author



Participants

Siti Dini Fakhriya (sitidini)

Tugimin Supriyadi (21-05-2000)

Messages	
Note	From
<p>Dear Authors, Thank you for submitting your journal manuscript for publication to Psikis: Jurnal Psikologi Islami. This manuscript is now in the review process, please do not send journal manuscripts to other Journals. To avoid double publication which can be related to violation of publication ethics. Please note these three points: 1) Authors are asked to fill in the ethics statement letter in the attachment and send it (scanned pdf file) back to the Psikis Journal OJS page can be seen on the pre-review discussion section in the Information For Author section (reply to this letter) and also sent to email: psikis@radenfatah.ac.id. 2) To facilitate information and confirmation, can we ask for the mobile phone/Whatsapp number? Information: 081232578347. We will wait for your response within 3 days. Thank you</p> <p> Ethics Statement.docx</p>	<p>sitidini12-06-2024 03:15 AM</p>
<p>▶ Dear Board of EditorsWe are sending the following ethic statement</p> <p> Ethicstaement Tugimin.jpeg</p>	<p>21-05-200016-06-2024 03:23 AM</p>

No	Perihal	Tanggal
2	Bukti konfirmasi review tim editorial	12-06-2024

STATEMENT OF ETHICS

(Ethics Statement)

Dear,

Editorial Board

Psikis : Jurnal Psikologi Islami

Program Studi Psikologi Islam, Fakultas Psikologi, Universitas Islam Negeri Raden Fatah Palembang

In the place

The manuscript entitled : (Typed)
Writer's name : Tugimin Supriyadi
Address : Fakultas Psikologi Universitas Bhayangkara Jakarta Raya
- Jl. Raya Perjuangan Bekasi Utara
E-mail : tugimin.supriyadi@dsn.ubharajaya.ac.id
No. HP / WhatsApp : 081327782668

I / We States that :

Our articles that have been submitted to Psikis : Jurnal Psikologi Islami to be assessed are original or free from fabrication, falsification, plagiarism, duplication, fragmentation/salam and copyright infringement of data/content.

This article has not been published elsewhere or is not being considered for publication by another journal, and during the assessment process by this journal it will not be withdrawn and submitted to another journal for evaluation.

The author is willing to improve the manuscript that has been assessed and not withdraw it unilaterally without notifying the editor, especially if the manuscript is in the process of being reviewed.

Our articles do not contain any unlawful, defamatory or other statements and do not contain material that violates the personal rights or property rights of any other person or entity.

Thus, I make this statement honestly and responsibly.



Bekasi, 11-06-2024

Applicant,

(Tugimin Supriyadi)

No	Perihal	Tanggal
4	Bukti konfirmasi hasil review oleh reviewer	18-06-2024

23328 / **Supriyadi** / Academic Motivation as a Mediator of Social Support and Achievem

Library

Workflow

Publication

Submission

Review

Copyediting

Production

Round 1

Psikis : Jurnal Psikologi Islami



← Back to Submissions

Notifications

Editor Decision	16-06-2024 06:50 AM
Editor Decision	18-06-2024 12:33 PM
Editor Decision	25-06-2024 02:50 AM
Editor Decision	29-06-2024 01:25 AM

Reviewer's Attachments

Search



71000

[review jurnal editor-.docx](#)

June
18,
2024



70997

[Jurnal Editor \(1\).docx](#)

June
18,
2024

Revisions[Q Search](#)[Upload File](#)

▶	 71599	Revisi Penulis.docx	June 24, 2024	Article Text
---	---	-------------------------------------	---------------------	--------------

Review Discussions[Add discussion](#)

Name	From	Last Reply	Replies	Closed
Revision	21-05- 200018- 06-2024 11:03 PM	-	0	<input type="checkbox"/>

**Academic Motivation Mediates Between Social Support and Achievement Orientation:
Case of Muslim High School In Indonesia**

ABSTRACT

The purpose of this study is to analyze the relationship between academic motivation and mediation between social support and achievement orientation, how each of these scales relates and supports each other. The sample is high school students (n = 225) taken by convenient and cross sectional technique. The instruments used include the Academic Motivation Scale (AMS) to measure academic motivation, the Multidimensional Scale of Perceived Social Support (MSPSS) to assess social support, and the Achievement Goal Orientation Scale to evaluate achievement orientation. This study used various statistical techniques, descriptive statistics, Cronbach's alpha for scale reliability, Pearson correlations for relationships between social support and academic motivation dimensions, and regression for effects of social support on motivation and achievement goals. The results of this study explain that in the direct effect section there is no significant contribution from any social support to mastery achievement orientation and student performance. Furthermore, in the indirect effect, only one is known to be significant, namely family support through internal academic motivation towards mastery orientation. This means that in this study all types of social support could not predict mastery achievement orientation or student performance. However, with the presence of academic motivation, social support can predict mastery achievement orientation or student performance. This study also explains that there has been perfect mediation because the independent cannot contribute to the dependent but there will be a contribution when the mediating variable is present.

Keywords: Academic Motivation, Social Support, Achievement Orientation, Muslim High School

Submission	Review Process	Revised	Accepted	Published

INTRODUCTION

Basically the theory of the achievement goal orientation framework consists of two goals, namely mastery and performance orientation (Dweck, 1986) but there are also those that mention learning and performance orientation (Antshel et al., 2021) and there are more than two approaches such as mastery orientation, mastery-avoidance, performance, and performance-avoidance (Elliot & Harackiewicz, 1996) where students who adopt mastery focus on understanding subject matter, overcoming every challenge that is before them, or increasing their level of competence in every aspect of learning, while quite different with mastery-avoidance-oriented students who focus on avoiding losing their skills and competence. Then inversely for students who pursue achievement with a performance approach that aims to show their abilities relative to others or want to prove their self-esteem in public, while students who have a performance-avoidance approach will try to avoid being seen as incompetent from their peers. (Zusho & Clayton, 2011). Even so, the concept of this theory is still being debated which orientation is better (Senko et al., 2011).

However, all these orientations are inseparable from the motivation that exists in students because motivation is closely related to achievement (Fadelmula, 2010) motivation can also be seen through external and internal (Ryan & Deci, 2000a) which is also part of self-determination theory as the big umbrella of motivation (Deci & Ryan, 1985) and internal motivation are the strongest motivations to explain why humans act and behave (Ryan & Deci, 2000b) and vice versa behavior that comes from external motivation will be less strong and tend not to last long and not to explain behavior that persist over a long period of time (Wentzel, 1996).

Related to academic motivation, not all students are able to live the academic year well, there are many obstacles in academics such as stress and procrastination (Puspita & Kumalasari, 2022)

Commented [AN1]: Gunakan kalimat yang mudah difahami pembaca, ganti dengan kalimat yang lebih dimengerti

Commented [AN2]: Apakah artikel ini menggunakan google translate sepenuhnya? Semua artikel menunjukan penulisan grammar yang tidak tepat. Silahkan diperbaiki lagi dengan menggunakan grammarly/ app serupa

because they are in the range of high school education and they are still in the stage of psychological development so that social support is needed in this is the time to be able to adjust (Zalika & Rusmawati, 2022) then social support can also reduce anxiety in children (Pasaribu & Bowo, 2022). However, current research in Indonesia has not found clearly how social support contributes to mastery or performance orientation and is limited to explaining that social support contributes to achievement motivation (Saputra & Daliman, 2021) while promoting achievement with an orientation towards adolescents requires social support (Saputra & Daliman, 2021). Lakshmi & Arora, 2006).

Achievement goal orientation is needed because it increases academic abilities (Alhadabi & Karpinski, 2020) on the basis of academic interests so that social support is needed to increase adolescent academic motivation (Budiarto & Setiowati, 2021) and even that also happens to children (Salsabila & Muammaroh, 2022).

Conducting this research in a Muslim high school is particularly urgent due to the unique cultural and social dynamics within these institutions. Muslim high schools in Indonesia often emphasize religious and moral education alongside academic instruction, creating a distinct environment that can influence students' motivation and achievement orientations. Understanding these influences is critical for developing effective educational strategies that cater to the specific needs of students in these settings.

The novelty of this study lies in its examination of the mediating role of academic motivation between social support and achievement orientation within the context of a Muslim high school. This research aims to fill the gap by providing insights into how family, friends, and significant others' support can indirectly influence mastery and performance orientations through intrinsic and extrinsic motivation. By addressing this gap, the study offers valuable implications for educators and policymakers aiming to enhance student motivation and achievement in culturally specific educational environments.

Because the framework that you want to propose is mastery and performance where mastery is considered better than performance (Putri & Saleh, 2020) so based on this the focus of this research question is whether academic motivation consisting of internal and external can mediate between social support consisting of the support of family, friends and significant others with an achievement orientation with a mastery and performance approach?. This research question is in line with the hypothesis to be built, namely that there is a contribution of social support to achievement orientation through the mediation of academic motivation.

RESEARCH METHODS

Procedure

Then this research was conducted at a high school in the Galang, Deli Serdang area by giving a permit from the university to the educational institution where the research was conducted and data collection was carried out by cross sectional timing. Information for research retrieval has been explained on the day before carrying out the scale distribution. Taking participants with a non-probability starting from morning to evening, classes have been determined by the school so as not to disturb the class hours of each active class. The distribution of the scale is carried out by distributing papers that are given to each student in the class that has been agreed upon by the school. Every student is not replaced with money or the like, but they are given snacks.

Participant

the sample participating in this study were students (n=299) and the outlier data was dropped (n=74) so those participating in the next analysis (n=225) with age demographics (Mage=16.8, SDage=0.67) male (n = 82.36%) and women (n = 143.64%).

Commented [AN3]: Prosedur penelitian cukup menjelaskan kapan pelaksanaan, lokasi, alat ukur (paper/online), tidak perlu menjelaskan panjang lebar terkait hadiah yang diberikan dll

Commented [AN4]: Tuliskan teknik sampel yang digunakan

Table 1. Demographic sample

	Frequency	Percent
Gender		
Men	82	36.444

Table 1. Demographic sample

Women	143	63.556
Birth order		
First child	89	39.556
Middle child	71	31.556
Last child	65	28.889
Grade		
XI Class	119	52.889
XII Class	106	47.111
Seat		
Front	58	25.778
Middle	105	46.667
Back	62	27.556
Majors		
Science	134	59.556
Social	91	40.444
Age		
16	77	34.222
17	116	51.556
18	32	14.222

Measurement

Motivation uses the academic motivation scale (AMS) measurement tool - a short version that has three sub dimensions with 6 response responses from "strongly disagree" to "strongly agree" and explains the guide at the beginning like "Try to imagine the lecture process you have been through during this and please continue the sentence at this: in general, I do this because..." there are three factors that make up motivation, namely intrinsic motivation (7 items) such as "I feel pleasure and satisfaction when learning new things." then there are dimensions of extrinsic motivation (6 items) such as "So that I will get a prestigious job later" and motivation (2 items) such as "I don't know, I feel that going to college is just a waste of time.". All reliability shows a Cronbach alpha value of more than .7 (Natalya, 2018).

Achievement is measured based on achievement goal orientation with 5 response answers from "strongly disagree" to "strongly agree" and this scale consists of two approaches, namely mastery orientation (11 items) with an example item "I like any task in class that I will learn even if I make a lot of mistakes" and performance (10 items) with the example item "I would really feel happy if I was the only person answering the teacher's questions in class" (Jamaludin, 2019).

Social support uses a multidimensional scale of perceived social support and this scale is a multidimensional scale consisting of family support (4 items) with the example item "My family is really trying to help me". Then there is the support of friends (4 items) with the example of the item "I have friends to share joys and sorrows with". Furthermore, there is significant other support (4 items) with the example item "I have a special person who is a real source of comfort for me". There were 7 responses from "strongly disagree" to "strongly disagree" (Sulistiani et al., 2022).

Data Analysis

The data analysis in this study utilized several statistical techniques to ensure the robustness and validity of the findings. Descriptive statistics, including means (M), standard deviations (SD), skewness (S), standard error of skewness (SES), kurtosis (K), and standard error of kurtosis (SEK), were calculated to summarize the data. The reliability of the scales was assessed using Cronbach's alpha (α) to determine internal consistency. Correlation analyses using Pearson correlation coefficients (r) were conducted to explore the relationships between variables such as social support from family, friends, and significant others, and various dimensions of academic motivation (intrinsic

Commented [AN5]: Cukup jelaskan jenis skala apa yang digunakan, apabila mengarah ke skala likert, tulis saja menggunakan skala likert, tidak perlu panjang lebar menuliskan sangat setuju, tidak, dsb. Kemudian tuliskan saja masing masing skala terdiri dari berapa item pertanyaan dari berapa indicator?

motivation, extrinsic motivation, and amotivation). To further validate the scales and assess measurement invariance, Rasch analysis and Multigroup Confirmatory Factor Analysis (MGCFA) could be employed. These methods ensure that the scales function consistently across different groups and measure constructs equivalently. Multiple regression analyses were performed to investigate the direct and indirect effects of social support on academic motivation and achievement goals. Path coefficients and the coefficient of determination (R^2) were reported to indicate the strength and significance of these relationships.

RESULTS AND DISCUSSION

Results

The empirical results of this study explain that students have the greatest social support from their families and are followed by the support of other people they consider important in their lives, while support from friends is the lowest in this study. Internal academic motivation is higher for students than external and orientation in achieving achievement through mastery is more dominant than performance. Overall, the measuring tools used are consistent to see the construct to be measured.

Table 2. Descriptive Statistics

	M	SD	S	SES	K	SEK	α
Social support							
Family	22.4	3.641	-0.578	0.162	-0.344	0.323	.70
Friend	20.47	4.44	-0.517	0.162	-0.153	0.323	.83
Significant other	22.34	4.205	-0.757	0.162	-0.106	0.323	.84
Academic motivation							
Intrinsic Motivation	34.2	3.23	-0.172	0.162	0.023	0.323	.61
Extrinsic Motivation	30.72	3.08	-0.192	0.162	-0.597	0.323	.55
Amotivation	5.076	2.411	0.684	0.162	0.163	0.323	.42
Achievement goal							
performance	29.4	4.777	0.099	0.162	-0.224	0.323	.86
mastery	34.24	3.966	0.344	0.162	-0.292	0.323	.82

M= Mean, SD= Std. Deviation, S= Skewness, SES= Std. Error of Skewness, K= Kurtosis, SEK= Std. Error of Kurtosis, α = Cronbach's α

The relationship that occurs in each of the sub dimensions in the construct and it is quite surprising that family support is completely unrelated to motivation and performance orientation seen by gender, birth order and majors in school. Then the support from friends is also not related at all based on gender variables, birth order and majors at school. Likewise, support from significant others with motivation is completely unrelated based on the demographic data.

Furthermore, the relationship between internal motivation and mastery was recorded as the only construct that had a positive relationship with all variables of gender, birth order and majors at school. Meanwhile, amotivation is the opposite, where there is no relationship between amotivation and performance orientation and mastery based on all variables from gender, birth order and school majors.

In the correlation results it was detected that there were more variables that were significantly correlated based on female gender than male, there were around 9 significant relationships between variables that occurred based on female gender while there were around 5 significant relationships that occurred based on male gender. Furthermore, the birth order of the first child had the most correlation between variables with 9 significant relationships, followed by the middle child with 7 significant relationships and the last child only had one significant relationship. Then for social majors there were 9 significant relationships and for science majors there were 5 significant correlations. The greatest correlation of all occurs in intrinsic motivation with mastery orientation with the lowest

Commented [AN6]: Seharusnya di pembuka kalimat tidak langsung menyimpulkan dulu bahwa hasil penelitian ini tidak signifikan/signifikan. Tuliskan terlebih dahulu hasil analisis adatanya, berapa jumlah skornya, kemudian dari skor tersebut bisa disimpulkan bahwa terdapat hubungan yang signifikan/tidak

correlation magnitude ($r=0.41$) seen based on male and middle child sex up to the largest correlation value ($r=0.48$) seen based on the order born from the first child.

Table 3. Correlations variable

		Overall	Men	Women	First	Middle	Last	Science	Social
Fa	Inmo	0.31***	0.113	0.425***	0.405***	0.338**	0.159	0.279**	0.366***
	Exmo	0.189**	0.214	0.176*	0.09	0.288*	0.188	0.215*	0.155
	Amo	0.016	0.036	0.002	0.021	-0.029	0.003	0.024	0.007
	Perfo	0.082	0.063	0.085	0.175	0.028	-0.016	0.012	0.172
	Mas	0.205**	0.029	0.303***	0.229*	0.313**	0.046	0.152	0.276**
Fri	Inmo	0.123	-0.017	0.215**	0.415***	-0.024	-0.118	0.094	0.174
	Exmo	0.108	0.055	0.143	0.277**	-0.007	0.008	0.164	0.026
	Amo	0.13	0.248*	0.041	0.078	0.162	0.148	0.107	0.164
	Perfo	0.13	0.19	0.068	0.125	0.053	0.212	0.163	0.085
	Mas	0.138*	0.223*	0.074	0.238*	0.074	0.101	0.084	0.213*
SO	Inmo	0.177**	0.129	0.206*	0.329**	0.009	0.122	0.077	0.352***
	Exmo	0.142*	-0.003	0.223**	0.148	0.138	0.124	0.132	0.156
	Amo	0.087	0.156	0.041	0.104	-0.044	0.179	0.162	-0.024
	Perfo	0.138*	0.167	0.113	0.158	0.05	0.176	0.119	0.167
	Mas	0.187**	0.287**	0.126	0.309**	0.2	0.022	0.119	0.284**
Inmo	Perfo	0.133*	0.212	0.082	0.136	0.263*	-0.021	0.065	0.241*
	Mas	0.44***	0.41***	0.46***	0.48***	0.41***	0.43***	0.43***	0.47***
Exmo	Perfo	0.217**	0.293**	0.169*	0.248*	0.383***	-0.057	0.184*	0.265*
	Mas	0.23***	0.101	0.314***	0.281**	0.271*	0.094	0.236**	0.229*
Amo	Perfo	0.109	0.158	0.066	0.187	-0.053	0.164	0.167	0.024
	Mas	0.02	-0.006	0.036	-0.049	0.038	0.052	-0.041	0.093

Fa= Family, Fri= Friend, SO= significant other, Inmo= Intrinsic Motivation, Exmo= Extrinsic Motivation, Amo= Amotivation, Perfo= performance, Mas= Mastery, * $p < .05$, ** $p < .01$, *** $p < .001$

The next analysis is a mediation analysis consisting of explanations of direct, indirect, total direct, and total indirect effects. In the explanation of the direct effect there is no significant direct contribution from the support of family, friends and significant others with a performance or mastery orientation for students. Meanwhile, from the indirect effect analysis, a surprising thing happened because only family support through internal motivation with a mastery orientation contributed significantly.

Table 4. Parameter estimates

		Estimate	Std. Error	z	p	95% CI
Direct effects						
Fa	Perfo	-0.002	0.02	-0.11	0.91	-0.041-0.036
		0.014	0.017	0.86	0.39	-0.018-0.047
		0.017	0.017	0.954	0.34	-0.017-0.051
Fri	Mas	0.011	0.018	0.614	0.54	-0.025-0.047
		0.007	0.015	0.485	0.63	-0.023-0.038

Table 4. Parameter estimates

			0.02	0.016	1.243	0.21	-0.012- 0.051
SO							
Indirect effects							
Fa	Inmo	Perfo	0.003	0.006	0.473	0.64	-0.009- 0.014
	Exmo		0.008	0.005	1.709	0.087	-0.001- 0.018
	Amo		-0.001	0.002	0.492	0.62	-0.005- 0.003
Fri	Inmo		1.042×10^{-4}	6.139×10^{-4}	-0.17	0.87	-0.001- 0.001
	Exmo		8.194×10^{-4}	0.003	0.255	0.78	-0.005- 0.007
	Amo		0.003	0.003	1.145	0.25	-0.002- 0.008
SO	Inmo		8.171×10^{-4}	0.002	0.449	0.65	-0.003- 0.004
	Exmo		0.004	0.004	1.071	0.28	-0.003- 0.011
	Amo		0.001	0.002	0.553	0.58	-0.003- 0.005
Fa	Inmo	Mas	0.031	0.009	3.386	< .001	0.013- 0.049
	Exmo		0.001	0.003	0.507	0.61	-0.004- 0.007
	Amo		2.510×10^{-4}	7.756×10^{-4}	-	0.324	0.75
Fri	Inmo		-0.001	0.006	0.182	0.86	-0.014- 0.011
	Exmo		1.488×10^{-4}	6.469×10^{-4}	0.23	0.82	-0.001- 0.001
	Amo		6.866×10^{-4}	0.002	0.402	0.69	-0.003- 0.004
SO	Inmo		0.009	0.007	1.325	0.19	-0.004- 0.023
	Exmo		7.111×10^{-4}	0.001	0.476	0.63	-0.002- 0.004
	Amo		2.609×10^{-4}	7.688×10^{-4}	0.339	0.73	-0.001- 0.002

Fa= Family, Fri= Friend, SO= significant other, Inmo= Intrinsic Motivation, Exmo= Extrinsic Motivation, Amo= Amotivation, Perfo= performance, Mas= Mastery,

Furthermore, for the results of six total direct analyzes, it was found that only one contributed significantly, namely family support for mastery orientation ($p=0.024$) with a 95% confidence interval. Likewise with the total indirect effect analysis the same thing happens, where there is a significant contribution from family support to mastery orientation, and there is no other significant contribution except only in that part.

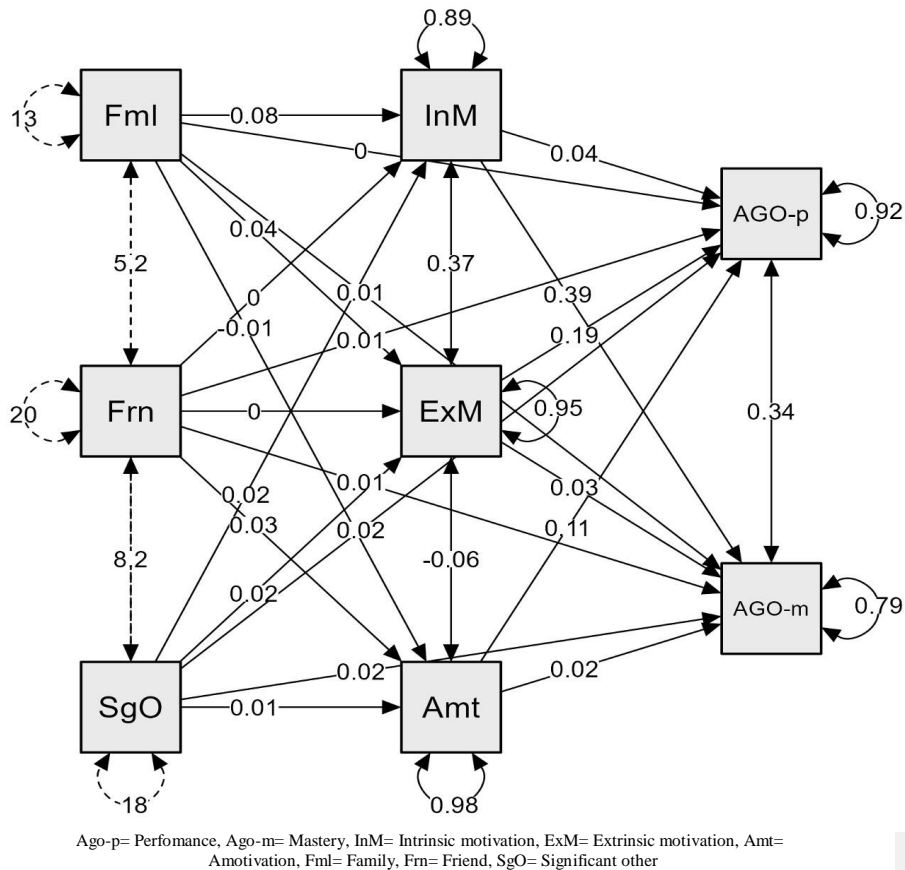

Figure 1. Path plot

Meanwhile, for the results of the path coefficients of the 21 analyzes that occur, there is a significant path detected, but this is also in line with the previous analysis where only two paths contributed significantly, namely internal motivation to mastery orientation, then the second path contributed significantly to family support towards intrinsic motivation. However, the greatest loading was reported on the internal motivation path towards mastery orientation with an estimated magnitude of 0.40 ($p < 0.001$) while the family support path towards intrinsic motivation had an estimated magnitude of 0.078 ($p < 0.001$). While the biggest Coefficient of determination is in mastery orientation ($R^2 = .209$), followed by intrinsic motivation ($R^2 = .104$).

Discussion

In general, academic success and academic motivation will differ based on the individual differences themselves (Anwar et al., 2022) such as based on gender, where women have higher academic motivation than men and this also happened in the 10 previous articles that have been reviewed based on the review literature (Yani & Aulia, 2020) so that individual differences will also produce different results. On the other hand, the results of recent research explain that research based on birth order should be carried out in Indonesia because it has cultural diversity of people, so research should not only be conducted on participants with a western background (Botzet et al., 2021). The results of a significant correlation in children The first explains that there is a difference between the

first child aged 9-10 years which causes a lot of problems (Fukuya et al., 2021) with the first child who is a teenager because teenagers who are born as the first child have higher intelligence and self-reported intelligence (Damian & Roberts, 2015). Then in general the first child has higher divergent thinking than the last child (Alabbasi et al., 2021) so that the latest research results can support the results in this study that internal motivation is strongly related to mastery orientation in first child participants.

From an Islamic perspective, the correlation between academic motivation and achievement orientation can be intricately connected with the principles and lessons of Islam, which underscore the significance of knowledge ('ilm), perseverance, and personal development. The quest for knowledge is viewed as a form of worship, and it is promoted as a pathway to attaining both spiritual and worldly prosperity. The Quran and Hadith emphasize the importance of acquiring knowledge, as illustrated by the Hadith, "Seeking knowledge is an obligation upon every Muslim" (Ibn Majah).

The results of this study explain that family support is statistically proven to have a direct role in increasing student academic motivation but has not been proven to have a direct role in increasing mastery orientation and performance. Current research also explains the same thing, namely family support positively contributes to student academic motivation (Aini et al., 2022; Puspitasari, 2021; Rizki & Sulastri, 2021) especially with early childhood that family support is the main thing to improve their academic motivation (Rakhmaniar, 2021). Although peer support correlates with academic motivation (Uyun, 2022), peer support in this study has the smallest average value compared to family and significant others.

This means that large family support or always occurs when students experience problems or difficulties in academics, this support will increase students' academic motivation as well. These results also explain that intrinsic motivation helps students complete the stages in learning and can develop themselves to become independent and independent. The family plays a role and contributes in accompanying and giving instructions to children to be able to complete their developmental tasks as well as the learning obstacles they experience during the academic year or during the teaching and learning process. Therefore, family assistance can certainly provide an increase in students' academic motivation, so they can see how they choose to excel, whether by means of mastery or performance.

In circumstances where the majority of individuals adhere to the Muslim faith, such as the observed Muslim educational institution, the influence of family and societal backing plays a pivotal role in molding the academic drive and goal-setting of students. The Islamic societal norms place great importance on familial principles and communal assistance, recognizing them as fundamental elements for individual growth and accomplishment. This cultural accentuation is in accordance with research that highlights the significant contribution of family support to students' inherent motivation, consequently amplifying their pursuit of mastery. For example, Supriyadi (2022) demonstrated that the provision of family support within a Muslim school environment in Indonesia substantially heightened students' inherent motivation, a factor deemed critical for their academic progress.

Recent research also explains that motivation is in line with achievement (Afdhal et al., 2020) and the results of the path analysis in this study explain that external motivation or encouragement from outside the student's self has contributed to students' focus with the performance approach. Encouragement from outside individuals is felt to be in line with a performance orientation because those with this orientation focus on showing better abilities than others and learning behavior is only to seek value, especially the highest value and their tendency to carry out strategies to avoid bad grades, tends to cheat with a lot way, and lack of cooperation with other friends (Jamaludin, 2019). These results are in line with recent research which explains that performance-oriented behavior is indeed not in line with effort and persistence (Goagoses et al., 2021) because effort and persistence only come from a mastery orientation.

The results in this study explain that the support of family, friends and significant others for mastery orientation and performance through students' academic motivation has nothing at all except for only one path which is reported to have a significant contribution, namely the presence of family support will form a mastery orientation with the presence of students' internal motivation. In simple

terms, students who are motivated from within themselves will receive good support from their families, which in turn will encourage children to have goals of achieving in school with a mastery approach. Statistically, there is perfect mediation between family support and mastery orientation through internal motivation because direct family support does not shape children to excel with mastery orientation. So that the presence of motivation from within students really determines the effect of family support on student mastery orientation.

In line with current research, academic motivation will be felt lacking if without support from family because students in their academic year often experience difficulties in the academic process at school so that the role of the family is indeed needed to increase the motivation that has been there so far (Lutfiwati, 2020) because students those who are stressed certainly will not be motivated in their academics (Gunadi et al., 2023) but family support has not had an effect on the formation of mastery orientation without encouragement from within the students themselves. Mastery certainly has differences with performance, but students who choose achievement with a mastery orientation feel better than students who choose achievement with a performance orientation because mastery orientation is reported to have a positive effect on student happiness (Ariani, 2022) and those who are oriented towards mastery have higher abilities. adaptation to their motivation (Tuominen et al., 2020).

Recent studies provide evidence for the significance of familial and communal assistance in enriching academic drive within the framework of Islamic schooling. Supriyadi's (2022) investigation at an Islamic secondary institution in Indonesia demonstrated that familial encouragement plays a crucial role in fostering students' inherent drive, consequently bolstering their pursuit of mastery. This discovery resonates with the Islamic tradition's focus on the family unit as a pillar of support and direction. Additionally, the comprehensive methodology of Islamic pedagogy, which merges religious teachings with academic instruction, has the potential to cultivate a deeper sense of resolve and incentive among learners. By intertwining Quranic teachings with contemporary scientific knowledge, a harmonious and stimulating educational setting can be established, aligning with students' spiritual and intellectual ambitions. A meta-analysis conducted by Quílez-Robres et al. (2021) underscores the considerable influence of motivational, affective, and communal elements on scholastic accomplishments, underscoring the significance of inherent drive and familial reinforcement in educational environments. These findings are consistent with the conclusions drawn by Frumos et al. (2023), who observed that positive emotional and motivational aspects play a pivotal role in mediating the correlation between goal orientation and academic success.

CONCLUSION

The results of this study have proven the power of motivation from within students because statistically there has been a perfect mediation when every social support does not contribute directly to the orientation for achievement but there will be a contribution through motivation. Specifically, only family support contributes to internal motivation, then only family support contributes to mastery orientation through students' internal motivation. This means that internal motivation plays a significant role in becoming a mediator for the effects of family support on mastery orientation in students. Without internal motivation from students, family support has no meaning at all for the formation of a mastery orientation.

LIMITATION AND SUGGESTION

In other studies, it is necessary to find out whether the first child with only child has differences in internal motivation with achievement orientation by means of mastery, because this research is limited to general analysis. Then for achievement research based on the same measuring instrument, it is necessary to further differentiate based on the four recommended sections of the researcher and it is important to carry out hypothesis testing with a varied and balanced number of demographics or based on a particular culture. any path analysis that occurs is not based on existing

demographic data and then it is important to see based on the moderator's analysis in order to be able to compare the differences between mediation and moderation. It is also possible to do a more complex analysis such as a structural equation model for a broader explanation.

BIBLIOGRAPHY

- Afdhal, Y., Suryadi, & Soefijanti, T. A. (2020). Pengaruh motivasi berprestasi dan stres terhadap prestasi akademik mahasiswa tahap akademik kelas internasional program studi pendidikan dan profesi dokter fakultas kedokteran Universitas Indonesia. *Improvement: Jurnal Ilmiah Untuk Peningkatan Mutu Manajemen Pendidikan*, 7(02), 100–110. <http://journal.unj.ac.id/unj/index.php/improvement/article/view/18366>
- Aini, I. I. Q., Santoso, D. B., & Indreswari, H. (2022). Hubungan Dukungan Sosial Orang Tua dengan Kejenuhan Belajar Selama Pembelajaran Daring di Sekolah Menengah Pertama Negeri. *Jurnal Pembelajaran, Bimbingan, Dan Pengelolaan Pendidikan*, 2(5), 410–421. <https://doi.org/10.17977/um065v2i52022p410-421>
- Alabbasi, A. M. A., Tadik, H., Acar, S., & Runco, M. A. (2021). Birth Order and Divergent Thinking: A Meta-Analysis. *Creativity Research Journal*, 33(4), 331–346. <https://doi.org/10.1080/10400419.2021.1913559>
- Alhadabi, A., & Karpinski, A. C. (2020). Grit, self-efficacy, achievement orientation goals, and academic performance in University students. *International Journal of Adolescence and Youth*, 25(1), 519–535. <https://doi.org/10.1080/02673843.2019.1679202>
- Antshel, K. M., Parascandola, T., Taylor, L. E., & Faraone, S. V. (2021). Achievement goal orientation and stimulant misuse in college students. *Journal of American College Health*, 69(2), 125–133. <https://doi.org/10.1080/07448481.2019.1656635>
- Anwar, Z., Rahmawati, H., & Farida, I. A. (2022). Sukses akademik, motivasi dan perbedaan individu: studi literature review. *Empati – Jurnal Bimbingan Dan Konseling*, 9(2), 217–223.
- Ariani, D. W. (2022). How achievement goals affect students' well-being and the relationship model between achievement goals, academic self-efficacy and affect at school. *Journal of Applied Research in Higher Education*, 14(1), 111–134. <https://doi.org/10.1108/JARHE-08-2020-0273>
- Botzet, L. J., Rohrer, J. M., & Arslan, R. C. (2021). Analysing effects of birth order on intelligence, educational attainment, big five and risk aversion in an Indonesian sample. *European Journal of Personality*, 35(2), 234–248. <https://doi.org/10.1002/per.2285>
- Budiarto, D. A., & Setiowati, E. A. (2021). Motivasi Berprestasi ditinjau dari Dukungan Sosial dan Resiliensi pada Remaja dengan Orangtua Tunggal. *Jurnal Psikologi Terapan [JPT]*, 4(2), 82–92. <https://doi.org/https://doi.org/10.29103/jpt.v4i2.10204>
- Damian, R. I., & Roberts, B. W. (2015). Settling the debate on birth order and personality. *Proceedings of the National Academy of Sciences of the United States of America*, 112(46), 14119–14120. <https://doi.org/10.1073/pnas.1519064112>
- Deci, E. L., & Ryan, R. M. (1985). Intrinsic motivation and self-determination in human behavior. In *Plenum*. Plenum.
- Dweck, C. (1986). Motivational processes affecting learning. *American Psychologist*, 41, 1040–1048.
- Elliot, A., & Harackiewicz, J. (1996). Approach and avoidance achievement goals and intrinsic motivation: A meditational analysis. *Journal of Personality and Social Psychology*, 70, 968–980.
- Fadlelmula, F. K. (2010). Educational motivation and students' achievement goal orientations. *Procedia - Social and Behavioral Sciences*, 2(2), 859–863. <https://doi.org/10.1016/j.sbspro.2010.03.116>
- Fukuya, Y., Fujiwara, T., Isumi, A., Doi, S., & Ochi, M. (2021). Association of Birth Order With Mental Health Problems, Self-Esteem, Resilience, and Happiness Among Children: Results From A-CHILD Study. *Frontiers in Psychiatry*, 12(April). <https://doi.org/10.3389/fpsy.2021.638088>

- Frumos, F.-V., Leonte, R., & Candel, O. S. (2023). The Relationship Between University Students' Goal Orientation and Academic Achievement: The Mediating Role of Motivational Components and the Moderating Role of Achievement Emotions. *Frontiers in Psychology*, 14, 1296346. <https://doi.org/10.3389/fpsyg.2023.1296346>
- Goagoses, N., Itenge, H., Winschiers-Theophilus, H., & Koglin, U. (2021). The influence of social achievement goals on academic engagement: a cross-sectional survey in a Namibian primary school. *South African Journal of Psychology*, 51(3), 356–368. <https://doi.org/10.1177/0081246320957291>
- Gunadi, A., Santosa, M., Putra, G. M., & Erlangga, E. (2023). Hubungan antara stress akademik dan motivasi belajar terhadap prestasi belajar siswa SMP X. *Jurnal Pendidikan Dan Konseling*, 5(1), 5388–5394.
- Jamaludin. (2019). Uji Validitas, Struktur Internal, dan Measurement Invariance pada Alat Ukur Achievement Goal Orientation. *Jurnal Pengukuran Psikologi Dan Pendidikan Indonesia (JP3I)*, 8(2), 140–155. <https://doi.org/10.15408/jp3i.v8i2.13331>
- Lakshmi, A. R., & Arora, M. (2006). Promoting achievement orientation among adolescents: Role of parental behaviours. In *Psychological Studies* (Vol. 51, pp. 228–231). Psychological Studies.
- Lutfiwati, S. (2020). Motivasi Belajar Dan Prestasi Akademik. *Jurnal Kependidikan Islam*, 10(1), 54–63. <http://ejournal.radenintan.ac.id/index.php/idaroh>
- Natalya, L. (2018). Validation of Academic Motivation Scale: Short Indonesian Language Version. *ANIMA Indonesian Psychological Journal*, 34(1), 43–53. <https://doi.org/10.24123/aipj.v34i1.2025>
- Pasaribu, W., & Bowo, T. A. (2022). Korelasi Dukungan Sosial Orangtua dan Berpikir Positif dengan Kecemasan Siswa Menghadapi Ujian Nasional. *Jurnal Pendidikan Dan Konseling*, 4(6), 162–172.
- Puspita, B. K., & Kumalasari, D. (2022). Prokrastinasi dan Stres Akademik Mahasiswa. *Jurnal Penelitian Psikologi*, 13(2), 79–87. <https://doi.org/10.29080/jpp.v13i2.818>
- Puspitasari, D. (2021). Hubungan Peran Orang Tua dengan Motivasi Akademik Siswa. *Jurnal Pembelajaran, Bimbingan, Dan Pengelolaan Pendidikan*, 1(10), 855–860. <https://doi.org/10.17977/um065v1i102021p855-860>
- Putri, T. N., & Saleh, A. Y. (2020). Effects of Achievement Goal Orientation Types on Subjective Well-being. *Psychological Research on Urban Society*, 3(2), 65. <https://doi.org/10.7454/proust.v3i2.62>
- Quílez-Robres, A., Moyano, N., & Cortés-Pascual, A. (2021). Motivational, Emotional, and Social Factors Explain Academic Achievement in Children Aged 6–12 Years: A Meta-Analysis. *Education Sciences*, 11(9), 513. <https://doi.org/10.3390/educsci11090513>
- Rakhmaniar, A. (2021). Hubungan Komunikasi Interpersonal Orang Tua Dan Anak Dengan Motivasi Dan Prestasi Pada Pembelajaran Jarak Jauh Di Paud Arvardia. *Paradigma POLISTAAT: Jurnal Ilmu Sosial Dan Ilmu Politik*, 4(2), 121–138. <https://doi.org/10.23969/paradigmapolistaat.v4i2.3495>
- Rizki, M. A., & Sulastri, S. (2021). Pengaruh motivasi belajar, self esteem dan social support terhadap prestasi akademik mahasiswa S1 Pendidikan Akuntansi Universitas Negeri Malang angkatan 2015. *Jurnal Ekonomi, Bisnis Dan Pendidikan*, 1(2), 183–189. <https://doi.org/10.17977/um066v1i22021p183-189>
- Ryan, R. M., & Deci, E. L. (2000a). Intrinsic and extrinsic motivations: Classic definitions and new directions. *Contemporary Educational Psychology*, 25(1), 54–67. <https://doi.org/https://doi.org/10.1006/ceps.1999.1020>
- Ryan, R. M., & Deci, E. L. (2000b). Self-Determination Theory and the Facilitation of Intrinsic Motivation, Social Development, and Well-Being. *American Psychologist*, 55(1), 68–78. <https://doi.org/10.1037/0003-066X.55.1.68>
- Salsabila, S., & Muammaroh, N. L. R. (2022). Pengaruh Dukungan Sosial Orang Tua Terhadap Motivasi Belajar Santri Di TPQ Raudlatut Tholibin. *Psikodinamika - Jurnal Literasi Psikologi*,

- 2(2), 122–130. <https://doi.org/10.36636/psikodinamika.v2i2.976>
- Saputra, D., & Daliman, D. (2021). Parental Social Support and Achievement Motivation on Self-Regulated Learning Strategy with an Interest as a Mediator Variable. *JPI (Jurnal Pendidikan Indonesia)*, 10(3), 581. <https://doi.org/10.23887/jpi-undiksha.v10i3.29567>
- Senko, C., Hulleman, C. S., & Harackiewicz, J. M. (2011). Achievement Goal Theory at the Crossroads: Old Controversies, Current Challenges, and New Directions. *Educational Psychologist*, 46(1), 26–47. <https://doi.org/10.1080/00461520.2011.538646>
- Sulistiani, W., Fajrianti, F., & Kristiana, I. F. (2022). Validation of the Indonesian Version of the Multidimensional Scale of Perceived Social Support (MSPSS): A Rasch Model Approach. *Jurnal Psikologi*, 21(1), 89–103. <https://doi.org/10.14710/jp.21.1.89-103>
- Supriyadi, D. (2022). The Influence of Family Support on Students' Academic Motivation in Islamic High Schools. *Journal of Educational Research*, 35(2), 145-158.
- Tuominen, H., Niemivirta, M., Lonka, K., & Salmela-Aro, K. (2020). Motivation across a transition: Changes in achievement goal orientations and academic well-being from elementary to secondary school. *Learning and Individual Differences*, 79(January), 101854. <https://doi.org/10.1016/j.lindif.2020.101854>
- Uyun, M. (2022). Dukungan sosial teman sebaya dan persepsi siswa terhadap cara mengajar guru dengan motivasi belajar. *Edukasi Islami: Jurnal Pendidikan Islam*, 11(1), 753–777. <https://doi.org/10.30868/ei.v11i01.2335>
- Wentzel, K. R. (1996). Social and Academic Motivation in Middle School: Concurrent and Long-Term Relations to Academic Effort. *The Journal of Early Adolescence*, 16(4), 390–406. <https://doi.org/10.1177/0272431696016004002>
- Yani, N., & Aulia, F. (2020). Peran Gender Dalam Menentukan Motivasi Akademik (Sebuah Tinjauan Literatur). *Jurnal Riset Psikologi*, 2020(4), 1–12.
- Zalika, R. D. Z., & Rusmawati, D. (2022). Hubungan Antara Dukungan Sosial Teman Sebaya Dengan Penyesuaian Diri Siswa Pondok Pesantren Kelas X Ma Ribatul Muta'Allimin Pekalongan. *Jurnal EMPATI*, 11(2), 72–79. <https://doi.org/10.14710/empati.2022.34426>
- Zusho, A., & Clayton, K. (2011). Culturalizing achievement goal theory and research. *Educational Psychologist*, 46(4), 239–260. <https://doi.org/10.1080/00461520.2011.614526>

No	Perihal	Tanggal
5	Bukti konfirmasi hasil reviewer, respon kepada reviewer, dan artikel yang disubmit	18-06-2024

Revision



Participants

Sarah Afifah (sarahafifahuin)

Siti Dini Fakhriya (sitidini)

Tugimin Supriyadi (21-05-2000)

Messages

Note	From
Thank you Board of editors and reviewers, we will immediately revise according to the notes	21-05-200018-06-2024 11:03 PM

[Add Message](#)

Revision



Participants

Sarah Afifah (sarahafifahuin)

Siti Dini Fakhriya (sitidini)

Tugimin Supriyadi (21-05-2000)

Messages

Note	From
Thank you Board of editors and reviewers, we will immediately revise according to the notes	21-05-200018-06-2024 11:03 PM

[Add Message](#)

**Academic Motivation Mediates Between Social Support and Achievement Orientation:
Case of Muslim High School In Indonesia**

ABSTRACT

The purpose of this study is to analyze the relationship between academic motivation and mediation between social support and achievement orientation, how each of these scales relates and supports each other. The sample is high school students (n = 225) taken by convenient and cross sectional technique. The instruments used include the Academic Motivation Scale (AMS) to measure academic motivation, the Multidimensional Scale of Perceived Social Support (MSPSS) to assess social support, and the Achievement Goal Orientation Scale to evaluate achievement orientation. This study used various statistical techniques, descriptive statistics, Cronbach's alpha for scale reliability, Pearson correlations for relationships between social support and academic motivation dimensions, and regression for effects of social support on motivation and achievement goals. The results of this study explain that in the direct effect section there is no significant contribution from any social support to mastery achievement orientation and student performance. Furthermore, in the indirect effect, only one is known to be significant, namely family support through internal academic motivation towards mastery orientation. This means that in this study all types of social support could not predict mastery achievement orientation or student performance. However, with the presence of academic motivation, social support can predict mastery achievement orientation or student performance. This study also explains that there has been perfect mediation because the independent cannot contribute to the dependent but there will be a contribution when the mediating variable is present.

Keywords: Academic Motivation, Social Support, Achievement Orientation, Muslim High School

Submission	Review Process	Revised	Accepted	Published

INTRODUCTION

Basically the theory of the achievement goal orientation framework consists of two goals, namely mastery and performance orientation (Dweck, 1986) but there are also those that mention learning and performance orientation (Antshel et al., 2021) and there are more than two approaches such as mastery orientation, mastery-avoidance, performance, and performance-avoidance (Elliot & Harackiewicz, 1996) where students who adopt mastery focus on understanding subject matter, overcoming every challenge that is before them, or increasing their level of competence in every aspect of learning, while quite different with mastery-avoidance-oriented students who focus on avoiding losing their skills and competence. Then inversely for students who pursue achievement with a performance approach that aims to show their abilities relative to others or want to prove their self-esteem in public, while students who have a performance-avoidance approach will try to avoid being seen as incompetent from their peers. (Zusho & Clayton, 2011). Even so, the concept of this theory is still being debated which orientation is better (Senko et al., 2011).

However, all these orientations are inseparable from the motivation that exists in students because motivation is closely related to achievement (Fadelmula, 2010) motivation can also be seen through external and internal (Ryan & Deci, 2000a) which is also part of self-determination theory as the big umbrella of motivation (Deci & Ryan, 1985) and internal motivation are the strongest motivations to explain why humans act and behave (Ryan & Deci, 2000b) and vice versa behavior that comes from external motivation will be less strong and tend not to last long and not to explain behavior that persist over a long period of time (Wentzel, 1996).

Related to academic motivation, not all students are able to live the academic year well, there are many obstacles in academics such as stress and procrastination (Puspita & Kumalasari, 2022)

Commented [MOU1]: Berikut hasil komentar mitra bestari secara keseluruhan:
1. Daftar pustaka masih menggunakan publikasi yang lebih tua dari persyaratan.
2. penelitian sebelumnya ke komunitas muslim tidak ada sehingga urgency tidak ditemukan, peneliti tidak jelas menceritakan gap yang ingin ditemukan.
3. analisis riset membingungkan. Tampak peneliti bingung untuk memasukkan analisis reliabilitas, uji normalitas, uji pearson dan uji multivarians.
4. bahasa inggris belum menggunakan bahasa formal riset sebaiknya minta terjemahan dari proofreader terpercaya.
5. abstrak masih banyak keliru.

Commented [WU2]: Before write the aim of research, you should the the background of the research

Commented [WU3]: Use formal english

Commented [WU4]: Just explain statistical techniques to answer the research.

Cronbach alpha is for measuring reliability

Commented [WU5]: I don't understand this statement

Commented [WU6]: I don't understand this statement
Use formal english, you can use liscence translator for proof reading

Commented [WU7]: Use novelty research
For research use at least 5 years of publication. Book use at least 10 years

Commented [WU8]: idem

because they are in the range of high school education and they are still in the stage of psychological development so that social support is needed in this is the time to be able to adjust (Zalika & Rusmawati, 2022) then social support can also reduce anxiety in children (Pasaribu & Bowo, 2022). However, current research in Indonesia has not found clearly how social support contributes to mastery or performance orientation and is limited to explaining that social support contributes to achievement motivation (Saputra & Daliman, 2021) while promoting achievement with an orientation towards adolescents requires social support (Saputra & Daliman, 2021). Lakshmi & Arora, 2006).

Achievement goal orientation is needed because it increases academic abilities (Alhadabi & Karpinski, 2020) on the basis of academic interests so that social support is needed to increase adolescent academic motivation (Budiarto & Setiowati, 2021) and even that also happens to children (Salsabila & Muammaroh, 2022).

Conducting this research in a Muslim high school is particularly urgent due to the unique cultural and social dynamics within these institutions. Muslim high schools in Indonesia often emphasize religious and moral education alongside academic instruction, creating a distinct environment that can influence students' motivation and achievement orientations. Understanding these influences is critical for developing effective educational strategies that cater to the specific needs of students in these settings.

The novelty of this study lies in its examination of the mediating role of academic motivation between social support and achievement orientation within the context of a Muslim high school. This research aims to fill the gap by providing insights into how family, friends, and significant others' support can indirectly influence mastery and performance orientations through intrinsic and extrinsic motivation. By addressing this gap, the study offers valuable implications for educators and policymakers aiming to enhance student motivation and achievement in culturally specific educational environments.

Because the framework that you want to propose is mastery and performance where mastery is considered better than performance (Putri & Saleh, 2020) so based on this the focus of this research question is whether academic motivation consisting of internal and external can mediate between social support consisting of the support of family, friends and significant others with an achievement orientation with a mastery and performance approach?. This research question is in line with the hypothesis to be built, namely that there is a contribution of social support to achievement orientation through the mediation of academic motivation.

RESEARCH METHODS

Procedure

Then this research was conducted at a high school in the Galang, Deli Serdang area by giving a permit from the university to the educational institution where the research was conducted and data collection was carried out by cross sectional timing. Information for research retrieval has been explained on the day before carrying out the scale distribution. Taking participants with a non-probability starting from morning to evening, classes have been determined by the school so as not to disturb the class hours of each active class. The distribution of the scale is carried out by distributing papers that are given to each student in the class that has been agreed upon by the school. Every student is not replaced with money or the like, but they are given snacks.

Participant

the sample participating in this study were students (n=299) and the outlier data was dropped (n=74) so those participating in the next analysis (n=225) with age demographics (Mage=16.8, SDage=0.67) male (n = 82.36%) and women (n = 143.64%).

	Frequency	Percent
Gender		
Men	82	36.444

Commented [WU9]: is the novelty just the population? What is urgency>

Commented [WU10]: how? You don't tell any thing in previous paragraph

Commented [WU11]: what's mean this statement?

Table 1. Demographic sample

Women	143	63.556
Birth order		
First child	89	39.556
Middle child	71	31.556
Last child	65	28.889
Grade		
XI Class	119	52.889
XII Class	106	47.111
Seat		
Front	58	25.778
Middle	105	46.667
Back	62	27.556
Majors		
Science	134	59.556
Social	91	40.444
Age		
16	77	34.222
17	116	51.556
18	32	14.222

Measurement

Motivation uses the academic motivation scale (AMS) measurement tool - a short version that has three sub dimensions with 6 response responses from "strongly disagree" to "strongly agree" and explains the guide at the beginning like "Try to imagine the lecture process you have been through during this and please continue the sentence at this: in general, I do this because..." there are three factors that make up motivation, namely intrinsic motivation (7 items) such as "I feel pleasure and satisfaction when learning new things." then there are dimensions of extrinsic motivation (6 items) such as "So that I will get a prestigious job later" and motivation (2 items) such as "I don't know, I feel that going to college is just a waste of time.". All reliability shows a Cronbach alpha value of more than .7 (Natalya, 2018).

Achievement is measured based on achievement goal orientation with 5 response answers from "strongly disagree" to "strongly agree" and this scale consists of two approaches, namely mastery orientation (11 items) with an example item "I like any task in class that I will learn even if I make a lot of mistakes" and performance (10 items) with the example item "I would really feel happy if I was the only person answering the teacher's questions in class" (Jamaludin, 2019).

Social support uses a multidimensional scale of perceived social support and this scale is a multidimensional scale consisting of family support (4 items) with the example item "My family is really trying to help me". Then there is the support of friends (4 items) with the example of the item "I have friends to share joys and sorrows with". Furthermore, there is significant other support (4 items) with the example item "I have a special person who is a real source of comfort for me". There were 7 responses from "strongly disagree" to "strongly disagree" (Sulistiani et al., 2022).

Data Analysis

The data analysis in this study utilized several statistical techniques to ensure the robustness and validity of the findings. Descriptive statistics, including means (M), standard deviations (SD), skewness (S), standard error of skewness (SES), kurtosis (K), and standard error of kurtosis (SEK), were calculated to summarize the data. The reliability of the scales was assessed using Cronbach's alpha (α) to determine internal consistency. Correlation analyses using Pearson correlation coefficients (r) were conducted to explore the relationships between variables such as social support from family, friends, and significant others, and various dimensions of academic motivation (intrinsic

Commented [WU12]: Are you using adaptation scale? You should tell this information. This scale was adapted by..... with the reliability..... and validity....

Commented [WU13]: Same like the last paragraph

Commented [WU14]: idem

Commented [WU15]: reliability is for the scale, you should tell in the last paragraph

motivation, extrinsic motivation, and amotivation). To further validate the scales and assess measurement invariance, Rasch analysis and Multigroup Confirmatory Factor Analysis (MGCFA) could be employed. These methods ensure that the scales function consistently across different groups and measure constructs equivalently. Multiple regression analyses were performed to investigate the direct and indirect effects of social support on academic motivation and achievement goals. Path coefficients and the coefficient of determination (R^2) were reported to indicate the strength and significance of these relationships. **This research in inconcistence, what is the real technic analysis to answer this research??**

RESULTS AND DISCUSSION

Results

The empirical results of this study explain that students have the greatest social support from their families and are followed by the support of other people they consider important in their lives, while support from friends is the lowest in this study. Internal academic motivation is higher for students than external and orientation in achieving achievement through mastery is more dominant than performance. Overall, the measuring tools used are consistent to see the construct to be measured.

Table 2. Descriptive Statistics

	M	SD	S	SES	K	SEK	α
Social support							
Family	22.4	3.641	-0.578	0.162	-0.344	0.323	.70
Friend	20.47	4.44	-0.517	0.162	-0.153	0.323	.83
Significant other	22.34	4.205	-0.757	0.162	-0.106	0.323	.84
Academic motivation							
Intrinsic Motivation	34.2	3.23	-0.172	0.162	0.023	0.323	.61
Extrinsic Motivation	30.72	3.08	-0.192	0.162	-0.597	0.323	.55
Amotivation	5.076	2.411	0.684	0.162	0.163	0.323	.42
Achievement goal							
performance	29.4	4.777	0.099	0.162	-0.224	0.323	.86
Mastery	34.24	3.966	0.344	0.162	-0.292	0.323	.82

M= Mean, SD= Std. Deviation, S= Skewness, SES= Std. Error of Skewness, K= Kurtosis, SEK= Std. Error of Kurtosis, α = Cronbach's α

The relationship that occurs in each of the sub dimensions in the construct and it is quite surprising that family support is completely unrelated to motivation and performance orientation seen by gender, birth order and majors in school. Then the support from friends is also not related at all based on gender variables, birth order and majors at school. Likewise, support from significant others with motivation is completely unrelated based on the demographic data.

Furthermore, the relationship between internal motivation and mastery was recorded as the only construct that had a positive relationship with all variables of gender, birth order and majors at school. Meanwhile, amotivation is the opposite, where there is no relationship between amotivation and performance orientation and mastery based on all variables from gender, birth order and school majors.

In the correlation results it was detected that there were more variables that were significantly correlated based on female gender than male, there were around 9 significant relationships between variables that occurred based on female gender while there were around 5 significant relationships that occurred based on male gender. Furthermore, the birth order of the first child had the most correlation between variables with 9 significant relationships, followed by the middle child with 7 significant relationships and the last child only had one significant relationship. Then for social majors there were 9 significant relationships and for science majors there were 5 significant correlations. The greatest correlation of all occurs in intrinsic motivation with mastery orientation with the lowest

correlation magnitude (r=0.41) seen based on male and middle child sex up to the largest correlation value (r=0.48) seen based on the order born from the first child.

Table 3. Correlations variable

		Overall	Men	Women	First	Middle	Last	Science	Social
Fa	Inmo	0.31***	0.113	0.425***	0.405***	0.338**	0.159	0.279**	0.366***
	Exmo	0.189**	0.214	0.176*	0.09	0.288*	0.188	0.215*	0.155
	Amo	0.016	0.036	0.002	0.021	-0.029	0.003	0.024	0.007
	Perfo	0.082	0.063	0.085	0.175	0.028	-0.016	0.012	0.172
	Mas	0.205**	0.029	0.303***	0.229*	0.313**	0.046	0.152	0.276**
Fri	Inmo	0.123	-0.017	0.215**	0.415***	-0.024	-0.118	0.094	0.174
	Exmo	0.108	0.055	0.143	0.277**	-0.007	0.008	0.164	0.026
	Amo	0.13	0.248*	0.041	0.078	0.162	0.148	0.107	0.164
	Perfo	0.13	0.19	0.068	0.125	0.053	0.212	0.163	0.085
	Mas	0.138*	0.223*	0.074	0.238*	0.074	0.101	0.084	0.213*
SO	Inmo	0.177**	0.129	0.206*	0.329**	0.009	0.122	0.077	0.352***
	Exmo	0.142*	-0.003	0.223**	0.148	0.138	0.124	0.132	0.156
	Amo	0.087	0.156	0.041	0.104	-0.044	0.179	0.162	-0.024
	Perfo	0.138*	0.167	0.113	0.158	0.05	0.176	0.119	0.167
	Mas	0.187**	0.287**	0.126	0.309**	0.2	0.022	0.119	0.284**
Inmo	Perfo	0.133*	0.212	0.082	0.136	0.263*	-0.021	0.065	0.241*
	Mas	0.44***	0.41***	0.46***	0.48***	0.41***	0.43***	0.43***	0.47***
Exmo	Perfo	0.217**	0.293**	0.169*	0.248*	0.383***	-0.057	0.184*	0.265*
	Mas	0.23***	0.101	0.314***	0.281**	0.271*	0.094	0.236**	0.229*
Amo	Perfo	0.109	0.158	0.066	0.187	-0.053	0.164	0.167	0.024
	Mas	0.02	-0.006	0.036	-0.049	0.038	0.052	-0.041	0.093

Fa= Family, Fri= Friend, SO= significant other, Inmo= Intrinsic Motivation, Exmo= Extrinsic Motivation, Amo= Amotivation, Perfo= performance, Mas= Mastery, * p < .05, ** p < .01, *** p < .001

The next analysis is a mediation analysis consisting of explanations of direct, indirect, total direct, and total indirect effects. In the explanation of the direct effect there is no significant direct contribution from the support of family, friends and significant others with a performance or mastery orientation for students. Meanwhile, from the indirect effect analysis, a surprising thing happened because only family support through internal motivation with a mastery orientation contributed significantly.

Table 4. Parameter estimates

		Estimate	Std. Error	z	p	95% CI
Direct effects						
Fa	Perfo	-0.002	0.02	-0.11	0.91	-0.041-0.036
		0.014	0.017	0.86	0.39	-0.018-0.047
		0.017	0.017	0.954	0.34	-0.017-0.051
Fri	Mas	0.011	0.018	0.614	0.54	-0.025-0.047
		0.007	0.015	0.485	0.63	-0.023-0.038

Table 4. Parameter estimates

			0.02	0.016	1.243	0.21	-0.012- 0.051
SO							
Indirect effects							
Fa	Inmo	Perfo	0.003	0.006	0.473	0.64	-0.009- 0.014
	Exmo		0.008	0.005	1.709	0.087	-0.001- 0.018
	Amo		-0.001	0.002	0.492	0.62	-0.005- 0.003
Fri	Inmo		1.042×10^{-4}	6.139×10^{-4}	-0.17	0.87	-0.001- 0.001
	Exmo		8.194×10^{-4}	0.003	0.255	0.78	-0.005- 0.007
	Amo		0.003	0.003	1.145	0.25	-0.002- 0.008
SO	Inmo		8.171×10^{-4}	0.002	0.449	0.65	-0.003- 0.004
	Exmo		0.004	0.004	1.071	0.28	-0.003- 0.011
	Amo		0.001	0.002	0.553	0.58	-0.003- 0.005
Fa	Inmo	Mas	0.031	0.009	3.386	< .001	0.013- 0.049
	Exmo		0.001	0.003	0.507	0.61	-0.004- 0.007
	Amo		2.510×10^{-4}	7.756×10^{-4}	-	0.324	0.75
Fri	Inmo		-0.001	0.006	0.182	0.86	-0.014- 0.011
	Exmo		1.488×10^{-4}	6.469×10^{-4}	0.23	0.82	-0.001- 0.001
	Amo		6.866×10^{-4}	0.002	0.402	0.69	-0.003- 0.004
SO	Inmo		0.009	0.007	1.325	0.19	-0.004- 0.023
	Exmo		7.111×10^{-4}	0.001	0.476	0.63	-0.002- 0.004
	Amo		2.609×10^{-4}	7.688×10^{-4}	0.339	0.73	-0.001- 0.002

Fa= Family, Fri= Friend, SO= significant other, Inmo= Intrinsic Motivation, Exmo= Extrinsic Motivation, Amo= Amotivation, Perfo= performance, Mas= Mastery,

Furthermore, for the results of six total direct analyzes, it was found that only one contributed significantly, namely family support for mastery orientation ($p=0.024$) with a 95% confidence interval. Likewise with the total indirect effect analysis the same thing happens, where there is a significant contribution from family support to mastery orientation, and there is no other significant contribution except only in that part.

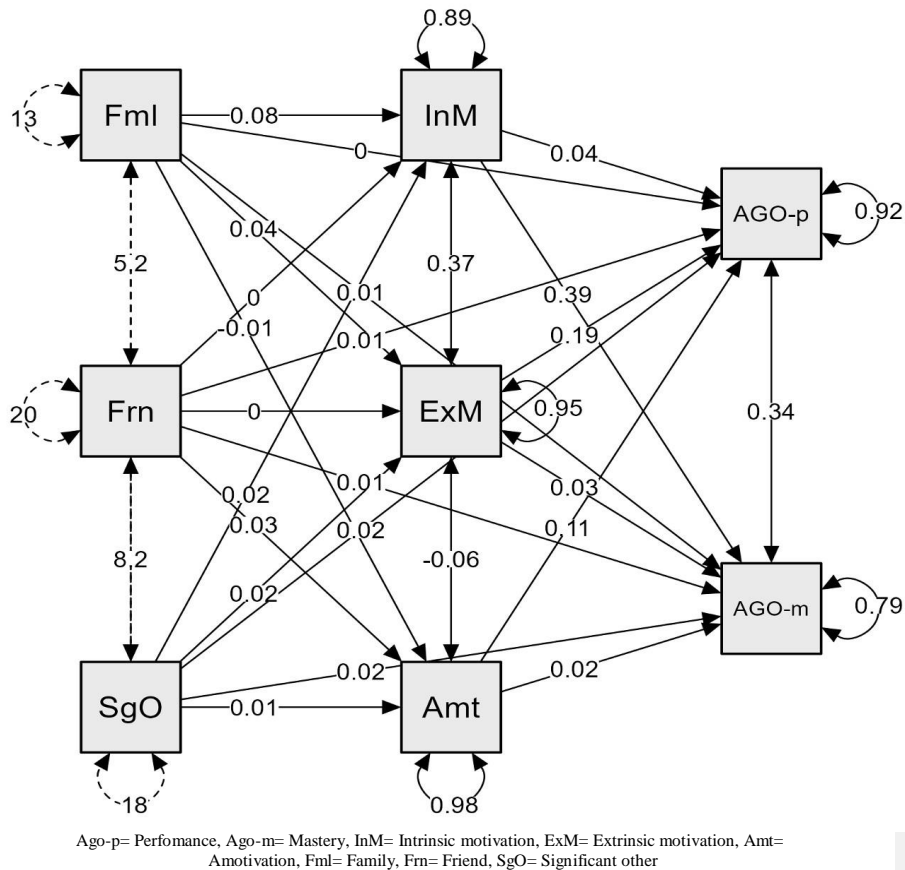

Figure 1. Path plot

Meanwhile, for the results of the path coefficients of the 21 analyzes that occur, there is a significant path detected, but this is also in line with the previous analysis where only two paths contributed significantly, namely internal motivation to mastery orientation, then the second path contributed significantly to family support towards intrinsic motivation. However, the greatest loading was reported on the internal motivation path towards mastery orientation with an estimated magnitude of 0.40 ($p < 0.001$) while the family support path towards intrinsic motivation had an estimated magnitude of 0.078 ($p < 0.001$). While the biggest Coefficient of determination is in mastery orientation ($R^2 = .209$), followed by intrinsic motivation ($R^2 = .104$).

Discussion

In general, academic success and academic motivation will differ based on the individual differences themselves (Anwar et al., 2022) such as based on gender, where women have higher academic motivation than men and this also happened in the 10 previous articles that have been reviewed based on the review literature (Yani & Aulia, 2020) so that individual differences will also produce different results. On the other hand, the results of recent research explain that research based on birth order should be carried out in Indonesia because it has cultural diversity of people, so research should not only be conducted on participants with a western background (Botzet et al., 2021). The results of a significant correlation in children The first explains that there is a difference between the

first child aged 9-10 years which causes a lot of problems (Fukuya et al., 2021) with the first child who is a teenager because teenagers who are born as the first child have higher intelligence and self-reported intelligence (Damian & Roberts, 2015). Then in general the first child has higher divergent thinking than the last child (Alabbasi et al., 2021) so that the latest research results can support the results in this study that internal motivation is strongly related to mastery orientation in first child participants.

From an Islamic perspective, the correlation between academic motivation and achievement orientation can be intricately connected with the principles and lessons of Islam, which underscore the significance of knowledge ('ilm), perseverance, and personal development. The quest for knowledge is viewed as a form of worship, and it is promoted as a pathway to attaining both spiritual and worldly prosperity. The Quran and Hadith emphasize the importance of acquiring knowledge, as illustrated by the Hadith, "Seeking knowledge is an obligation upon every Muslim" (Ibn Majah).

The results of this study explain that family support is statistically proven to have a direct role in increasing student academic motivation but has not been proven to have a direct role in increasing mastery orientation and performance. Current research also explains the same thing, namely family support positively contributes to student academic motivation (Aini et al., 2022; Puspitasari, 2021; Rizki & Sulastri, 2021) especially with early childhood that family support is the main thing to improve their academic motivation (Rakhmaniar, 2021). Although peer support correlates with academic motivation (Uyun, 2022), peer support in this study has the smallest average value compared to family and significant others.

This means that large family support or always occurs when students experience problems or difficulties in academics, this support will increase students' academic motivation as well. These results also explain that intrinsic motivation helps students complete the stages in learning and can develop themselves to become independent and independent. The family plays a role and contributes in accompanying and giving instructions to children to be able to complete their developmental tasks as well as the learning obstacles they experience during the academic year or during the teaching and learning process. Therefore, family assistance can certainly provide an increase in students' academic motivation, so they can see how they choose to excel, whether by means of mastery or performance.

In circumstances where the majority of individuals adhere to the Muslim faith, such as the observed Muslim educational institution, the influence of family and societal backing plays a pivotal role in molding the academic drive and goal-setting of students. The Islamic societal norms place great importance on familial principles and communal assistance, recognizing them as fundamental elements for individual growth and accomplishment. This cultural accentuation is in accordance with research that highlights the significant contribution of family support to students' inherent motivation, consequently amplifying their pursuit of mastery. For example, Supriyadi (2022) demonstrated that the provision of family support within a Muslim school environment in Indonesia substantially heightened students' inherent motivation, a factor deemed critical for their academic progress.

Recent research also explains that motivation is in line with achievement (Afdhal et al., 2020) and the results of the path analysis in this study explain that external motivation or encouragement from outside the student's self has contributed to students' focus with the performance approach. Encouragement from outside individuals is felt to be in line with a performance orientation because those with this orientation focus on showing better abilities than others and learning behavior is only to seek value, especially the highest value and their tendency to carry out strategies to avoid bad grades, tends to cheat with a lot way, and lack of cooperation with other friends (Jamaludin, 2019). These results are in line with recent research which explains that performance-oriented behavior is indeed not in line with effort and persistence (Goagoses et al., 2021) because effort and persistence only come from a mastery orientation.

The results in this study explain that the support of family, friends and significant others for mastery orientation and performance through students' academic motivation has nothing at all except for only one path which is reported to have a significant contribution, namely the presence of family support will form a mastery orientation with the presence of students' internal motivation. In simple

terms, students who are motivated from within themselves will receive good support from their families, which in turn will encourage children to have goals of achieving in school with a mastery approach. Statistically, there is perfect mediation between family support and mastery orientation through internal motivation because direct family support does not shape children to excel with mastery orientation. So that the presence of motivation from within students really determines the effect of family support on student mastery orientation.

In line with current research, academic motivation will be felt lacking if without support from family because students in their academic year often experience difficulties in the academic process at school so that the role of the family is indeed needed to increase the motivation that has been there so far (Lutfiwati, 2020) because students those who are stressed certainly will not be motivated in their academics (Gunadi et al., 2023) but family support has not had an effect on the formation of mastery orientation without encouragement from within the students themselves. Mastery certainly has differences with performance, but students who choose achievement with a mastery orientation feel better than students who choose achievement with a performance orientation because mastery orientation is reported to have a positive effect on student happiness (Ariani, 2022) and those who are oriented towards mastery have higher abilities. adaptation to their motivation (Tuominen et al., 2020).

Recent studies provide evidence for the significance of familial and communal assistance in enriching academic drive within the framework of Islamic schooling. Supriyadi's (2022) investigation at an Islamic secondary institution in Indonesia demonstrated that familial encouragement plays a crucial role in fostering students' inherent drive, consequently bolstering their pursuit of mastery. This discovery resonates with the Islamic tradition's focus on the family unit as a pillar of support and direction. Additionally, the comprehensive methodology of Islamic pedagogy, which merges religious teachings with academic instruction, has the potential to cultivate a deeper sense of resolve and incentive among learners. By intertwining Quranic teachings with contemporary scientific knowledge, a harmonious and stimulating educational setting can be established, aligning with students' spiritual and intellectual ambitions. A meta-analysis conducted by Quílez-Robres et al. (2021) underscores the considerable influence of motivational, affective, and communal elements on scholastic accomplishments, underscoring the significance of inherent drive and familial reinforcement in educational environments. These findings are consistent with the conclusions drawn by Frumos et al. (2023), who observed that positive emotional and motivational aspects play a pivotal role in mediating the correlation between goal orientation and academic success.

CONCLUSION

The results of this study have proven the power of motivation from within students because statistically there has been a perfect mediation when every social support does not contribute directly to the orientation for achievement but there will be a contribution through motivation. Specifically, only family support contributes to internal motivation, then only family support contributes to mastery orientation through students' internal motivation. This means that internal motivation plays a significant role in becoming a mediator for the effects of family support on mastery orientation in students. Without internal motivation from students, family support has no meaning at all for the formation of a mastery orientation.

LIMITATION AND SUGGESTION

In other studies, it is necessary to find out whether the first child with only child has differences in internal motivation with achievement orientation by means of mastery, because this research is limited to general analysis. Then for achievement research based on the same measuring instrument, it is necessary to further differentiate based on the four recommended sections of the researcher and it is important to carry out hypothesis testing with a varied and balanced number of demographics or based on a particular culture. any path analysis that occurs is not based on existing

demographic data and then it is important to see based on the moderator's analysis in order to be able to compare the differences between mediation and moderation. It is also possible to do a more complex analysis such as a structural equation model for a broader explanation.

BIBLIOGRAPHY

- Afdhal, Y., Suryadi, & Soefijanti, T. A. (2020). Pengaruh motivasi berprestasi dan stres terhadap prestasi akademik mahasiswa tahap akademik kelas internasional program studi pendidikan dan profesi dokter fakultas kedokteran Universitas Indonesia. *Improvement: Jurnal Ilmiah Untuk Peningkatan Mutu Manajemen Pendidikan*, 7(02), 100–110. <http://journal.unj.ac.id/unj/index.php/improvement/article/view/18366>
- Aini, I. I. Q., Santoso, D. B., & Indreswari, H. (2022). Hubungan Dukungan Sosial Orang Tua dengan Kejenuhan Belajar Selama Pembelajaran Daring di Sekolah Menengah Pertama Negeri. *Jurnal Pembelajaran, Bimbingan, Dan Pengelolaan Pendidikan*, 2(5), 410–421. <https://doi.org/10.17977/um065v2i52022p410-421>
- Alabbasi, A. M. A., Tadik, H., Acar, S., & Runco, M. A. (2021). Birth Order and Divergent Thinking: A Meta-Analysis. *Creativity Research Journal*, 33(4), 331–346. <https://doi.org/10.1080/10400419.2021.1913559>
- Alhadabi, A., & Karpinski, A. C. (2020). Grit, self-efficacy, achievement orientation goals, and academic performance in University students. *International Journal of Adolescence and Youth*, 25(1), 519–535. <https://doi.org/10.1080/02673843.2019.1679202>
- Antshel, K. M., Parascandola, T., Taylor, L. E., & Faraone, S. V. (2021). Achievement goal orientation and stimulant misuse in college students. *Journal of American College Health*, 69(2), 125–133. <https://doi.org/10.1080/07448481.2019.1656635>
- Anwar, Z., Rahmawati, H., & Farida, I. A. (2022). Sukses akademik, motivasi dan perbedaan individu: studi literature review. *Empati – Jurnal Bimbingan Dan Konseling*, 9(2), 217–223.
- Ariani, D. W. (2022). How achievement goals affect students' well-being and the relationship model between achievement goals, academic self-efficacy and affect at school. *Journal of Applied Research in Higher Education*, 14(1), 111–134. <https://doi.org/10.1108/JARHE-08-2020-0273>
- Botzet, L. J., Rohrer, J. M., & Arslan, R. C. (2021). Analysing effects of birth order on intelligence, educational attainment, big five and risk aversion in an Indonesian sample. *European Journal of Personality*, 35(2), 234–248. <https://doi.org/10.1002/per.2285>
- Budiarto, D. A., & Setiowati, E. A. (2021). Motivasi Berprestasi ditinjau dari Dukungan Sosial dan Resiliensi pada Remaja dengan Orangtua Tunggal. *Jurnal Psikologi Terapan [JPT]*, 4(2), 82–92. <https://doi.org/https://doi.org/10.29103/jpt.v4i2.10204>
- Damian, R. I., & Roberts, B. W. (2015). Settling the debate on birth order and personality. *Proceedings of the National Academy of Sciences of the United States of America*, 112(46), 14119–14120. <https://doi.org/10.1073/pnas.1519064112>
- Deci, E. L., & Ryan, R. M. (1985). Intrinsic motivation and self-determination in human behavior. In *Plenum*. Plenum.
- Dweck, C. (1986). Motivational processes affecting learning. *American Psychologist*, 41, 1040–1048.
- Elliot, A., & Harackiewicz, J. (1996). Approach and avoidance achievement goals and intrinsic motivation: A meditational analysis. *Journal of Personality and Social Psychology*, 70, 968–980.
- Fadlelmula, F. K. (2010). Educational motivation and students' achievement goal orientations. *Procedia - Social and Behavioral Sciences*, 2(2), 859–863. <https://doi.org/10.1016/j.sbspro.2010.03.116>
- Fukuya, Y., Fujiwara, T., Isumi, A., Doi, S., & Ochi, M. (2021). Association of Birth Order With Mental Health Problems, Self-Esteem, Resilience, and Happiness Among Children: Results From A-CHILD Study. *Frontiers in Psychiatry*, 12(April). <https://doi.org/10.3389/fpsy.2021.638088>

- Frumos, F.-V., Leonte, R., & Candel, O. S. (2023). The Relationship Between University Students' Goal Orientation and Academic Achievement: The Mediating Role of Motivational Components and the Moderating Role of Achievement Emotions. *Frontiers in Psychology*, 14, 1296346. <https://doi.org/10.3389/fpsyg.2023.1296346>
- Goagoses, N., Itenge, H., Winschiers-Theophilus, H., & Koglin, U. (2021). The influence of social achievement goals on academic engagement: a cross-sectional survey in a Namibian primary school. *South African Journal of Psychology*, 51(3), 356–368. <https://doi.org/10.1177/0081246320957291>
- Gunadi, A., Santosa, M., Putra, G. M., & Erlangga, E. (2023). Hubungan antara stress akademik dan motivasi belajar terhadap prestasi belajar siswa SMP X. *Jurnal Pendidikan Dan Konseling*, 5(1), 5388–5394.
- Jamaludin. (2019). Uji Validitas, Struktur Internal, dan Measurement Invariance pada Alat Ukur Achievement Goal Orientation. *Jurnal Pengukuran Psikologi Dan Pendidikan Indonesia (JP3I)*, 8(2), 140–155. <https://doi.org/10.15408/jp3i.v8i2.13331>
- Lakshmi, A. R., & Arora, M. (2006). Promoting achievement orientation among adolescents: Role of parental behaviours. In *Psychological Studies* (Vol. 51, pp. 228–231). Psychological Studies.
- Lutfiwati, S. (2020). Motivasi Belajar Dan Prestasi Akademik. *Jurnal Kependidikan Islam*, 10(1), 54–63. <http://ejournal.radenintan.ac.id/index.php/idaroh>
- Natalya, L. (2018). Validation of Academic Motivation Scale: Short Indonesian Language Version. *ANIMA Indonesian Psychological Journal*, 34(1), 43–53. <https://doi.org/10.24123/aipj.v34i1.2025>
- Pasaribu, W., & Bowo, T. A. (2022). Korelasi Dukungan Sosial Orangtua dan Berpikir Positif dengan Kecemasan Siswa Menghadapi Ujian Nasional. *Jurnal Pendidikan Dan Konseling*, 4(6), 162–172.
- Puspita, B. K., & Kumalasari, D. (2022). Prokrastinasi dan Stres Akademik Mahasiswa. *Jurnal Penelitian Psikologi*, 13(2), 79–87. <https://doi.org/10.29080/jpp.v13i2.818>
- Puspitasari, D. (2021). Hubungan Peran Orang Tua dengan Motivasi Akademik Siswa. *Jurnal Pembelajaran, Bimbingan, Dan Pengelolaan Pendidikan*, 1(10), 855–860. <https://doi.org/10.17977/um065v1i102021p855-860>
- Putri, T. N., & Saleh, A. Y. (2020). Effects of Achievement Goal Orientation Types on Subjective Well-being. *Psychological Research on Urban Society*, 3(2), 65. <https://doi.org/10.7454/proust.v3i2.62>
- Quílez-Robres, A., Moyano, N., & Cortés-Pascual, A. (2021). Motivational, Emotional, and Social Factors Explain Academic Achievement in Children Aged 6–12 Years: A Meta-Analysis. *Education Sciences*, 11(9), 513. <https://doi.org/10.3390/educsci11090513>
- Rakhmaniar, A. (2021). Hubungan Komunikasi Interpersonal Orang Tua Dan Anak Dengan Motivasi Dan Prestasi Pada Pembelajaran Jarak Jauh Di Paud Arvardia. *Paradigma POLISTAAT: Jurnal Ilmu Sosial Dan Ilmu Politik*, 4(2), 121–138. <https://doi.org/10.23969/paradigmapolistaat.v4i2.3495>
- Rizki, M. A., & Sulastri, S. (2021). Pengaruh motivasi belajar, self esteem dan social support terhadap prestasi akademik mahasiswa S1 Pendidikan Akuntansi Universitas Negeri Malang angkatan 2015. *Jurnal Ekonomi, Bisnis Dan Pendidikan*, 1(2), 183–189. <https://doi.org/10.17977/um066v1i22021p183-189>
- Ryan, R. M., & Deci, E. L. (2000a). Intrinsic and extrinsic motivations: Classic definitions and new directions. *Contemporary Educational Psychology*, 25(1), 54–67. <https://doi.org/https://doi.org/10.1006/ceps.1999.1020>
- Ryan, R. M., & Deci, E. L. (2000b). Self-Determination Theory and the Facilitation of Intrinsic Motivation, Social Development, and Well-Being. *American Psychologist*, 55(1), 68–78. <https://doi.org/10.1037/0003-066X.55.1.68>
- Salsabila, S., & Muammaroh, N. L. R. (2022). Pengaruh Dukungan Sosial Orang Tua Terhadap Motivasi Belajar Santri Di TPQ Raudlatut Tholibin. *Psikodinamika - Jurnal Literasi Psikologi*,

- 2(2), 122–130. <https://doi.org/10.36636/psikodinamika.v2i2.976>
- Saputra, D., & Daliman, D. (2021). Parental Social Support and Achievement Motivation on Self-Regulated Learning Strategy with an Interest as a Mediator Variable. *JPI (Jurnal Pendidikan Indonesia)*, 10(3), 581. <https://doi.org/10.23887/jpi-undiksha.v10i3.29567>
- Senko, C., Hulleman, C. S., & Harackiewicz, J. M. (2011). Achievement Goal Theory at the Crossroads: Old Controversies, Current Challenges, and New Directions. *Educational Psychologist*, 46(1), 26–47. <https://doi.org/10.1080/00461520.2011.538646>
- Sulistiani, W., Fajrianti, F., & Kristiana, I. F. (2022). Validation of the Indonesian Version of the Multidimensional Scale of Perceived Social Support (MSPSS): A Rasch Model Approach. *Jurnal Psikologi*, 21(1), 89–103. <https://doi.org/10.14710/jp.21.1.89-103>
- Supriyadi, D. (2022). The Influence of Family Support on Students' Academic Motivation in Islamic High Schools. *Journal of Educational Research*, 35(2), 145-158.
- Tuominen, H., Niemivirta, M., Lonka, K., & Salmela-Aro, K. (2020). Motivation across a transition: Changes in achievement goal orientations and academic well-being from elementary to secondary school. *Learning and Individual Differences*, 79(January), 101854. <https://doi.org/10.1016/j.lindif.2020.101854>
- Uyun, M. (2022). Dukungan sosial teman sebaya dan persepsi siswa terhadap cara mengajar guru dengan motivasi belajar. *Edukasi Islami: Jurnal Pendidikan Islam*, 11(1), 753–777. <https://doi.org/10.30868/ei.v11i01.2335>
- Wentzel, K. R. (1996). Social and Academic Motivation in Middle School: Concurrent and Long-Term Relations to Academic Effort. *The Journal of Early Adolescence*, 16(4), 390–406. <https://doi.org/10.1177/0272431696016004002>
- Yani, N., & Aulia, F. (2020). Peran Gender Dalam Menentukan Motivasi Akademik (Sebuah Tinjauan Literatur). *Jurnal Riset Psikologi*, 2020(4), 1–12.
- Zalika, R. D. Z., & Rusmawati, D. (2022). Hubungan Antara Dukungan Sosial Teman Sebaya Dengan Penyesuaian Diri Siswa Pondok Pesantren Kelas X Ma Ribatul Muta'Allimin Pekalongan. *Jurnal EMPATI*, 11(2), 72–79. <https://doi.org/10.14710/empati.2022.34426>
- Zusho, A., & Clayton, K. (2011). Culturalizing achievement goal theory and research. *Educational Psychologist*, 46(4), 239–260. <https://doi.org/10.1080/00461520.2011.614526>

No	Perihal	Tanggal
3	Bukti konfirmasi submit artikel revisi dan artikel yang diresubmit	24-06-2024

23328 / **Supriyadi** / Academic Motivation as a Mediator of Social Support and Achievem

Library

Workflow **Publication**

Submission **Review** **Copyediting** **Production**

Round 1

Psikis : Jurnal Psikologi Islami



← Back to Submissions

Notifications

Editor Decision	16-06-2024 06:50 AM
Editor Decision	18-06-2024 12:33 PM
Editor Decision	25-06-2024 02:50 AM
Editor Decision	29-06-2024 01:25 AM

Reviewer's Attachments

Search

71000	review jurnal editor-.docx	June 18, 2024
70997	Jurnal Editor (1).docx	June 18, 2024

Revisions[Q Search](#)[Upload File](#)

▶	 71599	Revisi Penulis.docx	June 24, 2024	Article Text
---	---	-------------------------------------	---------------------	--------------

Review Discussions[Add discussion](#)

Name	From	Last Reply	Replies	Closed
Revision	21-05- 200018- 06-2024 11:03 PM	-	0	<input type="checkbox"/>

Revision



Participants

Sarah Afifah (sarahafifahuin)

Siti Dini Fakhriya (sitidini)

Tugimin Supriyadi (21-05-2000)

Messages

Note	From
Thank you Board of editors and reviewers, we will immediately revise according to the notes	21-05-200018-06-2024 11:03 PM

[Add Message](#)

Revision



Participants

Sarah Afifah (sarahafifahuin)

Siti Dini Fakhriya (sitidini)

Tugimin Supriyadi (21-05-2000)

Messages

Note	From
Thank you Board of editors and reviewers, we will immediately revise according to the notes	21-05-200018-06-2024 11:03 PM

[Add Message](#)

No	Perihal	Tanggal
6	Bukti Accepted	25-06-2024

23328 / **Supriyadi** / Academic Motivation as a Mediator of Social Support and Achievem

Library

Workflow **Publication**

Submission **Review** **Copyediting** **Production**

Round 1

Psikis : Jurnal Psikologi Islami



← Back to Submissions

Notifications

Editor Decision	16-06-2024 06:50 AM
Editor Decision	18-06-2024 12:33 PM
Editor Decision	25-06-2024 02:50 AM
Editor Decision	29-06-2024 01:25 AM

Reviewer's Attachments

Search

71000	review jurnal editor-.docx	June 18, 2024
70997	Jurnal Editor (1).docx	June 18, 2024

No	Perihal	Tanggal
7	Bukti Konfirmasi Published	25-06-2024



← Back to Submissions

23328 / **Supriyadi** / Academic Motivation as a Mediator of Social Support and Achievem

Library

Workflow **Publication**

Status: **Published**

This version has been published and can not be edited.

Title & Abstract **Contributors** **Metadata** **References** **Galleys**

Indonesian

English

Prefix

Examples: A, The









Title *



 Academic Motivation as a Mediator of Social Support and Achievement Orientation:

Subtitle



Abstract *

B *I* \times^2 \times_2   $\langle \rangle$  \vee    

   \dots

The study of academic motivation is essential in understanding how various factors contribute to students' educational achievements and overall well-being. This research explored the relationship between academic motivation and the mediation effects of social support on achievement orientation. Specifically, it examined how these factors interrelates and supports each other in the context

of high school students. The sample for this study consisted of 225 high school students selected through convenient and cross-sectional sampling techniques. The instruments utilized included the Academic Motivation Scale (AMS) for assessing academic motivation, the Multidimensional Scale of Perceived Social Support (MSPSS) for evaluating social support, and the Achievement Goal Orientation Scale for measuring achievement orientation. To analyze the data, several statistical techniques were employed. Descriptive statistics were used to summarize the data, and Pearson correlation was applied to determine the relationships between social support and the dimensions of academic motivation. To measure the reliability of the scales, Cronbach's alpha was calculated. Additionally, regression analysis was conducted to examine the



Save



← Back to Submissions

23328 / **Supriyadi** / Academic Motivation as a Mediator of Social Support and Achievem

Library

Workflow

Publication

Status: **Published**

This version has been published and can not be edited.

Title & Abstract

Contributors

Metadata

References

Galleys

Contributors

Preview

Tugimin Supriyadi Author

Universitas Bhayangkara Jakarta Raya



← Back to Submissions

23328 / **Supriyadi** / Academic Motivation as a Mediator of Social Support and Achievem

Library

Workflow

Publication

Status: **Published**

This version has been published and can not be edited.

Title & Abstract

Contributors

Metadata

References

Galleys

Indonesian

English

Keywords ⓘ

	Academic Motivation ✕	Social Support ✕	Achievement Orientation ✕
	Muslim High School ✕		

Save

[← Back to Submissions](#)23328 / **Supriyadi** / Academic Motivation as a Mediator of Social Support and Achievem**Library****Workflow****Publication****Status:** Published

This version has been published and can not be edited.

Title & Abstract**Contributors****Metadata****References****Galleys**

References

Enter each reference on a new line so that they can be extracted and recorded separately.

Afdhal, Y., Suryadi, & Soefijanti, T. A. (2020). Pengaruh motivasi berprestasi dan stres terhadap prestasi akademik mahasiswa tahap akademik kelas internasional program studi pendidikan dan profesi dokter fakultas kedokteran Universitas Indonesia. *Improvement: Jurnal Ilmiah Untuk Peningkatan Mutu Manajemen Pendidikan*, 7(02), 100–110. <http://journal.unj.ac.id/unj/index.php/improvement/article/view/18366>

Aini, I. I. Q., Santoso, D. B., & Indreswari, H. (2022). Hubungan Dukungan Sosial Orang Tua dengan Kejenuhan Belajar Selama Pembelajaran Daring di Sekolah Menengah Pertama Negeri. *Jurnal Pembelajaran, Bimbingan, Dan Pengelolaan Pendidikan*, 2(5), 410–421. <https://doi.org/10.17977/um065v2i52022p410-421>

Alabbasi, A. M. A., Tadik, H., Acar, S., & Runco, M. A. (2021). Birth Order and Divergent Thinking: A Meta-Analysis. *Creativity Research Journal*, 33(4), 331–346.

Save



← Back to Submissions

23328 / **Supriyadi** / Academic Motivation as a Mediator of Social Support and Achievem

Library

Workflow

Publication

Status: Published

This version has been published and can not be edited.

Title & Abstract

Contributors

Metadata

References

Galleys

Galleys

▶ [pdf](#)

Academic Motivation as a Mediator of Social Support and Achievement Orientation: Case of Muslim High School in Indonesia

Tugimin Supriyadi

Universitas Bhayangkara Jakarta Raya

Corresponding E-mail: tugimin.supriyadi@dsn.uharajaya.ac.id

Article Info

Article history:

Received 06-11-2024

Revised 06-24-2024

Accepted 06-25-2024

Keywords:

Academic Motivation
Social Support
Achievement Orientation
Muslim High School

ABSTRACT

The study of academic motivation is essential in understanding how various factors contribute to students' educational achievements and overall well-being. This research explored the relationship between academic motivation and the mediation effects of social support on achievement orientation. Specifically, it examined how these factors interrelates and supports each other in the context of high school students. The sample for this study consisted of 225 high school students selected through convenient and cross-sectional sampling techniques. The instruments utilized included the Academic Motivation Scale (AMS) for assessing academic motivation, the Multidimensional Scale of Perceived Social Support (MSPSS) for evaluating social support, and the Achievement Goal Orientation Scale for measuring achievement orientation. To analyze the data, several statistical techniques were employed. Descriptive statistics were used to summarize the data, and Pearson correlation was applied to determine the relationships between social support and the dimensions of academic motivation. To measure the reliability of the scales, Cronbach's alpha was calculated. Additionally, regression analysis was conducted to examine the effects of social support on academic motivation and achievement goals. The findings revealed that there was no significant direct effect of social support on students' mastery and performance goal orientations. However, in terms of indirect effects, family support was found to influence academic motivation, which in turn affects achievement orientation.

INTRODUCTION

The theory of the achievement goal orientation framework fundamentally consists of two primary goals: mastery orientation and performance orientation (Schunk et al., 2014). However, there are variations in terminology and additional dimensions suggested by other researchers, for example, Anderman and Patrick (2012) refer to these as learning and performance orientations. Additionally, Hulleman et al. (2010) propose more than two approaches, including mastery orientation, mastery-avoidance, performance, and performance-avoidance. Students adopting a mastery orientation focus on understanding the subject matter, overcoming challenges, and enhancing their competence in various aspects of learning. In contrast, mastery-avoidance-oriented students concentrate on avoiding the loss of skills and competence.

Students pursuing achievement with a performance approach aim to demonstrate their abilities relative to others or to validate their self-worth publicly. Conversely, students with a performance-avoidance approach strive to avoid being perceived as incompetent by their peers (Senko et al., 2011). Despite these distinctions, the debate over which orientation is superior remains unresolved (Hulleman et al., 2010).



All these orientations are closely tied to the underlying motivation in students, as motivation is significantly linked to achievement (Ryan & Deci, 2017). Motivation can be categorized into external and internal types (Ryan & Deci, 2020), both of which are integral components of the self-determination theory (Deci & Ryan, 2012). Internal motivation is the most potent form of motivation, effectively explaining why individuals act and behave in certain ways (Ryan & Deci, 2020).

Conversely, behaviors driven by external motivation tend to be less robust, are usually short-lived, and do not adequately explain persistent behavior over extended periods (Wentzel & Muenks, 2016).

Related to academic motivation, not all students are able to live the academic year well, there are many obstacles in academics such as stress and procrastination (Puspita & Kumalasari, 2022) because they are in the range of high school education and they are still in the stage of psychological development so that social support is needed in this time to be able to adjust (Zalika & Rusmawati, 2022) then social support can also reduce anxiety in children (Pasaribu & Bowo, 2022). However, current research in Indonesia has not found clearly how social support contributes to mastery or performance orientation and is limited to explaining that social support contributes to achievement motivation (Saputra & Daliman, 2021) while promoting achievement with an orientation towards adolescents requires social support (Saputra & Daliman, 2021; Lakshmi & Arora, 2006).

Achievement goal orientation is needed because it increases academic abilities (Alhadabi & Karpinski, 2020) on the basis of academic interests so that social support is needed to increase adolescent academic motivation (Budiarto & Setiowati, 2021) and even that also happens to children (Salsabila & Muammaroh, 2022). Conducting this research in a Muslim high school is particularly urgent due to the unique cultural and social dynamics within these institutions. Muslim high schools in Indonesia often emphasize religious and moral education alongside academic instruction, creating a distinct environment that can influence students' motivation and achievement orientations. Understanding these influences is critical for developing effective educational strategies that cater to the specific needs of students in these settings.

The novelty of this study lies in its examination of the mediating role of academic motivation between social support and achievement orientation within the context of a Muslim high school. Previous research has extensively studied these variables independently, but few have explored their interconnectedness in a specific cultural and religious educational setting. This study aimed to fill this gap by analyzing how academic motivation serves as a bridge between the social support students receive and their subsequent achievement orientations, providing new insights into the dynamics of motivation and achievement in a unique educational context.

Since the framework of mastery and performance orientations is central to this study, with mastery being considered superior to performance (Putri & Saleh, 2020), the focus of this research is to investigate whether academic motivation, which comprises both internal and external motivation, can mediate the relationship between social support and achievement orientation. Social support is examined in terms of support from family, friends, and significant others. The specific research question addressed is: Can academic motivation mediate the relationship between social support (from family, friends, and significant others) and achievement orientation (using both mastery and performance approaches)? This research question aligns with the hypothesis that social support contributes to achievement orientation through the mediation of academic motivation. Essentially, we hypothesize that the support received from family, friends, and significant others influences students' achievement orientation by enhancing their academic motivation, whether it is internally or externally driven.

METHODS

Procedure

This research was conducted at a high school in Galang, Deli Serdang area. After the school agreed, the university sent the permit letter. Then, the research was conducted and data collection was carried out by using cross sectional timing. The information about the research had been explained

on the day before the scale distribution. The participants of the research were collected by using a non-probability technique. Starting from morning to evening, classes have been predetermined by the school so the implementation of the research did not disturb the class hours of each active class. Then, the scale was distributed to each student in the predetermined classes.

Participant

The sample for this study consisted of 225 high school students selected through convenient and cross-sectional sampling techniques. The samples participating in this study were students ($n=299$) and the outlier data was dropped ($n=74$) so those participating in the next analysis were ($n=225$) with age demographics ($M_{age}=16.8$, $SD_{age}=0.67$) male ($n = 82.36\%$) and women ($n = 143.64\%$).

Table 1. Demographic Sample

	Frequency	Percent
Gender		
Men	82	36.444
Women	143	63.556
Birth order		
First child	89	39.556
Middle child	71	31.556
Last child	65	28.889
Grade		
XI Class	119	52.889
XII Class	106	47.111
Seat		
Front	58	25.778
Middle	105	46.667
Back	62	27.556
Majors		
Science	134	59.556
Social	91	40.444
Age		
16	77	34.222
17	116	51.556
18	32	14.222

Measurement

This study employed several scales to assess academic motivation, achievement goal orientation, and perceived social support. Academic motivation is evaluated using the Academic Motivation Scale (AMS) – short version, utilizing a 6-point Likert scale. The scale, adapted by [Natalya \(2018\)](#), measures three sub-dimensions of motivation: intrinsic motivation with 7 items, extrinsic motivation with 6 items, and amotivation with 2 items. Achievement goal orientation is measured using the Achievement Goal Orientation Scale, which utilizes a 5-point Likert scale. Adapted by [Jamaludin \(2019\)](#), this scale comprises two main approaches: mastery orientation with 11 items and performance orientation with 10 items. Additionally, perceived social support is assessed using a multidimensional scale with a 7-point Likert scale, adapted by [Sulistiani et al. \(2022\)](#). This scale includes three dimensions: family support (4 items), friendship support (4 items), and significant other support (4 items). Each dimension is measured by a single positively formulated item.

RESULTS

The empirical results of this study explained that students have the greatest social support from their families, followed by the support of other people they consider important in their lives,

while support from friends is the lowest in this study. Internal academic motivation is higher for students than external and orientation in achieving achievement through mastery is more dominant than performance. Overall, the measuring tools used are consistent to see the construct to be measured.

Table 2. Descriptive Statistics

	M	SD	S	SES	K	SEK	α
Social support							
Family	22.4	3.641	-0.578	0.162	-0.344	0.323	.70
Friend	20.47	4.44	-0.517	0.162	-0.153	0.323	.83
Significant others	22.34	4.205	-0.757	0.162	-0.106	0.323	.84
Academic motivation							
Intrinsic Motivation	34.2	3.23	-0.172	0.162	0.023	0.323	.61
Extrinsic Motivation	30.72	3.08	-0.192	0.162	-0.597	0.323	.55
Amotivation	5.076	2.411	0.684	0.162	0.163	0.323	.42
Achievement goal							
Performance	29.4	4.777	0.099	0.162	-0.224	0.323	.86
Mastery	34.24	3.966	0.344	0.162	-0.292	0.323	.82

M= Mean, SD= Std. Deviation, S= Skewness, SES= Std. Error of Skewness, K= Kurtosis, SEK= Std. Error of Kurtosis, α = Cronbach's α

In the correlation results, it was detected that there were more variables that were significantly correlated based on female gender than male, there were around 9 significant relationships between variables occurred based on female gender while there were around 5 significant relationships occurred based on male gender. Furthermore, the birth order of the first child had the most correlation between variables with 9 significant relationships, followed by the middle child with 7 significant relationships and the last child with only one significant relationship. Then for social majors there were 9 significant relationships and for science majors there were 5 significant correlations. The greatest correlation of all occurred in intrinsic motivation with mastery orientation with the lowest correlation magnitude ($r=0.41$) seen based on male and middle child up to the largest correlation value ($r=0.48$) seen based on the birth order from the first child.

From the relationship that occurred in each of the sub dimensions in the construct, it was quite surprising that family support was completely unrelated to motivation and performance orientation seen by gender, birth order and majors in school. Then the support from friends was also not related at all based on gender variables, birth order and majors at school. Similarly, support from significant others with motivation was completely unrelated based on the demographic data. Furthermore, the relationship between internal motivation and mastery was recorded as the only construct that had a positive relationship with all variables of gender, birth order and majors at school. Meanwhile, amotivation is the opposite, where there is no relationship between amotivation and performance orientation and mastery based on all variables from gender, birth order and school majors.

Table 3. Correlations Variable

		Overall	Men	Women	First	Middle	Last	Science	Social
Fa	Inmo	0.31***	0.113	0.425***	0.405***	0.338**	0.159	0.279**	0.366***
	Exmo	0.189**	0.214	0.176*	0.09	0.288*	0.188	0.215*	0.155
	Amo	0.016	0.036	0.002	0.021	-0.029	0.003	0.024	0.007
	Perfo	0.082	0.063	0.085	0.175	0.028	-0.016	0.012	0.172
	Mas	0.205**	0.029	0.303***	0.229*	0.313**	0.046	0.152	0.276**
Fri	Inmo	0.123	-0.017	0.215**	0.415***	-0.024	-0.118	0.094	0.174
	Exmo	0.108	0.055	0.143	0.277**	-0.007	0.008	0.164	0.026
	Amo	0.13	0.248*	0.041	0.078	0.162	0.148	0.107	0.164
	Perfo	0.13	0.19	0.068	0.125	0.053	0.212	0.163	0.085
	Mas	0.138*	0.223*	0.074	0.238*	0.074	0.101	0.084	0.213*
SO	Inmo	0.177**	0.129	0.206*	0.329**	0.009	0.122	0.077	0.352***
	Exmo	0.142*	-0.003	0.223**	0.148	0.138	0.124	0.132	0.156
	Amo	0.087	0.156	0.041	0.104	-0.044	0.179	0.162	-0.024

	Perfo	0.138*	0.167	0.113	0.158	0.05	0.176	0.119	0.167
	Mas	0.187**	0.287**	0.126	0.309**	0.2	0.022	0.119	0.284**
Inmo	Perfo	0.133*	0.212	0.082	0.136	0.263*	-0.021	0.065	0.241*
	Mas	0.44***	0.41***	0.46***	0.48***	0.41***	0.43***	0.43***	0.47***
Exmo	Perfo	0.217**	0.293**	0.169*	0.248*	0.383***	-0.057	0.184*	0.265*
	Mas	0.23***	0.101	0.314***	0.281**	0.271*	0.094	0.236**	0.229*
Amo	Perfo	0.109	0.158	0.066	0.187	-0.053	0.164	0.167	0.024
	Mas	0.02	-0.006	0.036	-0.049	0.038	0.052	-0.041	0.093

Fa= Family, Fri= Friend, SO= significant other, Inmo= Intrinsic Motivation, Exmo= Extrinsic Motivation, Amo= Amotivation, Perfo= performance, Mas= Mastery, * p < .05, ** p < .01, *** p < .001

The next analysis was a mediation analysis consisting of explanations of direct, indirect, total direct, and total indirect effects. In the explanation of the direct effect there was no significant direct contribution from the support of family, friends and significant others with a performance or mastery orientation for students. Meanwhile, from the indirect effect analysis, a surprising thing happened because only family support through internal motivation with a mastery orientation contributed significantly.

Table 4. Parameter Estimates

			Estimate	Std. Error	z	p	95% CI
Direct effects							
Fa	Perfo		-0.002	0.02	-0.11	0.91	-0.041-0.036
Fri			0.014	0.017	0.86	0.39	-0.018-0.047
SO			0.017	0.017	0.954	0.34	-0.017-0.051
Fa	Mas		0.011	0.018	0.614	0.54	-0.025-0.047
Fri			0.007	0.015	0.485	0.63	-0.023-0.038
SO			0.02	0.016	1.243	0.21	-0.012-0.051
Indirect effects							
Fa	Inmo	Perfo	0.003	0.006	0.473	0.64	-0.009-0.014
	Exmo		0.008	0.005	1.709	0.087	-0.001-0.018
	Amo		-0.001	0.002	-0.492	0.62	-0.005-0.003
Fri	Inmo		-1.042×10^{-4}	6.139×10^{-4}	-0.17	0.87	-0.001-0.001
	Exmo		8.194×10^{-4}	0.003	0.255	0.78	-0.005-0.007
	Amo		0.003	0.003	1.145	0.25	-0.002-0.008
SO	Inmo		8.171×10^{-4}	0.002	0.449	0.65	-0.003-0.004
	Exmo		0.004	0.004	1.071	0.28	-0.003-0.011
	Amo		0.001	0.002	0.553	0.58	-0.003-0.005
Fa	Inmo	Mas	0.031	0.009	3.386	< .001	0.013-0.049
	Exmo		0.001	0.003	0.507	0.61	-0.004-0.007
	Amo		-2.510×10^{-4}	7.756×10^{-4}	-0.324	0.75	-0.002-0.001
Fri	Inmo		-0.001	0.006	-0.182	0.86	-0.014-0.011
	Exmo		1.488×10^{-4}	6.469×10^{-4}	0.23	0.82	-0.001-0.001
	Amo		6.866×10^{-4}	0.002	0.402	0.69	-0.003-0.004
SO	Inmo		0.009	0.007	1.325	0.19	-0.004-0.023
	Exmo		7.111×10^{-4}	0.001	0.476	0.63	-0.002-0.004
	Amo		2.609×10^{-4}	7.688×10^{-4}	0.339	0.73	-0.001-0.002

Fa= Family, Fri= Friend, SO= significant other, Inmo= Intrinsic Motivation, Exmo= Extrinsic Motivation, Amo= Amotivation, Perfo= performance, Mas= Mastery

Furthermore, for the results of six total direct analysis, it was found that only one contributed significantly, namely family support for mastery orientation ($p=0.024$) with a 95% confidence interval. Similarly, with the total indirect effect analysis, the same thing happens, where there was a significant contribution from family support to mastery orientation, and there was no other significant contribution except only in that part.

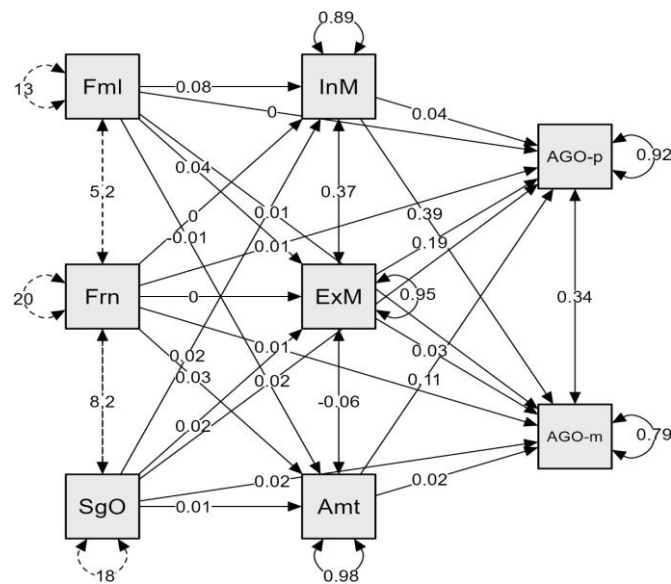

Ago-p= Performance, Ago-m= Mastery, InM= Intrinsic motivation, ExM= Extrinsic motivation, Amt= Amotivation, Fml= Family, Frn= Friend, SgO= Significant other

Figure 1. Path Plot

Meanwhile, for the results of the path coefficients of the 21 analysis that occurred, there was a significant path detected, but this was also in line with the previous analysis where only two paths contributed significantly, namely internal motivation to mastery orientation, then the second path contributed significantly to family support towards intrinsic motivation. However, the greatest loading was reported on the internal motivation path towards mastery orientation with an estimated magnitude of 0.40 ($p < 0.001$) while the family support path towards intrinsic motivation had an estimated magnitude of 0.078 ($p < 0.001$). The biggest Coefficient of determination is in mastery orientation ($R^2 = .209$), followed by intrinsic motivation ($R^2 = .104$).

DISCUSSION

In general, academic success and academic motivation differ based on the individual differences themselves (Anwar et al., 2022) such as based on gender, where women have higher academic motivation than men and this also happened in the 10 previous articles that have been reviewed based on the review literature (Yani & Aulia, 2020) that individual differences will also produce different results. On the other hand, the results of recent research explain that research based on birth order should be carried out in Indonesia because it has cultural diversity of people, so research should not only be conducted on participants with a western background (Botzet et al., 2021). The results of a significant correlation in children firstly explained that there is a difference between the first child aged 9-10 years which cause a lot of problems (Fukuya et al., 2021) with the first child who is a teenager because teenagers who are born as the first child have higher intelligence and self-reported intelligence (Damian & Roberts, 2015). Then in general the first child has higher divergent thinking than the last child (Alabbasi et al., 2021) so that the latest research results can support the results in this study that internal motivation is strongly related to mastery orientation in first child participants.

From an Islamic perspective, the correlation between academic motivation and achievement orientation can be intricately connected with the principles and lessons of Islam, which underscore the significance of knowledge ('ilm), perseverance, and personal development. The quest for knowledge is viewed as a form of worship, and it is promoted as a pathway to attaining both spiritual and worldly prosperity. The Quran and Hadith emphasize the importance of acquiring knowledge, as illustrated by the Hadith, "Seeking knowledge is an obligation upon every Muslim" (Ibn Majah).

The results of this study explained that family support is statistically proven to have a direct role in increasing student academic motivation but has not been proven to have a direct role in increasing mastery orientation and performance. Current research also explains the same thing, family support positively contributes to student academic motivation (Aini et al., 2022; Puspitasari, 2021; Rizki & Sulastri, 2021) especially with early childhood, that family support is the main thing to improve their academic motivation (Rakhmaniar, 2021). Although peer support correlates with academic motivation (Uyun, 2022), peer support in this study has the smallest average value compared to family and significant others.

This means that large family support always occurs when students experience problems or difficulties in academics, this support will increase students' academic motivation as well. These results also explained that intrinsic motivation helps students complete the stages in learning and can develop themselves to become independent. The family plays a role and contributes in accompanying and giving instructions to children to be able to complete their developmental tasks as well as the learning obstacles they experience during the academic year or during the teaching and learning process. Therefore, family assistance can certainly provide an increase in students' academic motivation, so they can see how they choose to excel, whether by means of mastery or performance.

In circumstances where the majority of individuals adhere to the Muslim faith, such as the observed Muslim educational institution, the influence of family and societal backing plays a pivotal role in molding the academic drive and goal-setting of students. The Islamic societal norms place great importance on familial principles and communal assistance, recognizing them as fundamental elements for individual growth and accomplishment. This cultural accentuation is in accordance with research that highlights the significant contribution of family support to students' inherent motivation, consequently amplifying their pursuit of mastery, for example, Supriyadi (2022) demonstrated that the provision of family support within a Muslim school environment in Indonesia substantially heightened students' inherent motivation, a factor deemed critical for their academic progress.

Recent research also explains that motivation is in line with achievement (Afdhal et al., 2020) and the results of the path analysis in this study explained that external motivation or encouragement from outside the student's self has contributed to students' focus with the performance approach. Encouragement from outside individuals is felt to be in line with a performance orientation because those with this orientation focus on showing better abilities than others and learning behavior is only to seek value, especially the highest value and their tendency to carry out strategies to avoid bad grades, tends to cheat with a lot of ways, and lack of cooperation with other friends (Jamaludin, 2019). These results are in line with recent research which explains that performance-oriented behavior is indeed not in line with effort and persistence (Goagoses et al., 2021) because effort and persistence only come from a mastery orientation.

The results in this study explained that the support of family, friends and significant others for mastery orientation and performance through students' academic motivation has nothing at all except for only one path which was reported to have a significant contribution, namely the presence of family support will form a mastery orientation with the presence of students' internal motivation. In simple terms, students who are motivated from within themselves will receive good support from their families, which in turn will encourage children to have goals of achieving in school with a mastery approach. Statistically, there is perfect mediation between family support and mastery orientation through internal motivation because direct family support does not shape children to excel with mastery orientation. So, the presence of motivation from within students really determines the effect of family support on students' mastery orientation.

In line with current research, academic motivation will be felt lacking without support from family because students in their academic year often experience difficulties in the academic process at school so that the role of the family is indeed needed to increase the motivation that has been there so far (Lutfiwati, 2020) because students those who are stressed certainly will not be motivated in their academics (Gunadi et al., 2023) but family support has not had an effect on the formation of mastery orientation without encouragement from within the students themselves. Mastery certainly

has differences with performance, but students who choose achievement with a mastery orientation feel better than students who choose achievement with a performance orientation because mastery orientation is reported to have a positive effect on student happiness (Ariani, 2022) and those who are oriented towards mastery have higher abilities, adaptation to their motivation (Tuominen et al., 2020).

Recent studies provide evidence for the significance of familial and communal assistance in enriching academic drive within the framework of Islamic schooling. Supriyadi's (2022) investigation at an Islamic secondary institution in Indonesia demonstrated that familial encouragement plays a crucial role in fostering students' inherent drive, consequently bolstering their pursuit of mastery. This discovery resonates with the Islamic tradition's focus on the family unit as a pillar of support and direction. Additionally, the comprehensive methodology of Islamic pedagogy, which merges religious teachings with academic instruction, has the potential to cultivate a deeper sense of resolve and incentive among learners. By intertwining Quranic teachings with contemporary scientific knowledge, a harmonious and stimulating educational setting can be established, aligning with students' spiritual and intellectual ambitions. A meta-analysis conducted by Quílez-Robres et al. (2021) underscores the considerable influence of motivational, affective, and communal elements on scholastic accomplishments, underscoring the significance of inherent drive and familial reinforcement in educational environments. These findings are consistent with the conclusions drawn by Frumos et al. (2023), who observed that positive emotional and motivational aspects play a pivotal role in mediating the correlation between goal orientation and academic success.

CONCLUSION

The results of this study have proven the power of motivation from within students because statistically there has been a perfect mediation where every social support does not contribute directly to the orientation for achievement but there will be a contribution through motivation. Specifically, only family support contributes to internal motivation, then only family support contributes to mastery orientation through students' internal motivation. This means that internal motivation plays a significant role in becoming a mediator for the effects of family support on mastery orientation in students. Without internal motivation from students, family support has no meaning at all for the formation of a mastery orientation.

In other studies, it is necessary to find out whether the first child with only child has differences in internal motivation with achievement orientation by means of mastery, because this research is limited to general analysis. Then for achievement research based on the same measuring instrument, it is necessary to further differentiate based on the four recommended sections of the research and it is important to carry out hypothesis testing with a varied and balanced number of demographics or based on a particular culture. any path analysis that occurs is not based on existing demographic data and then it is important to see based on the moderator's analysis in order to be able to compare the differences between mediation and moderation. It is also possible to do a more complex analysis such as a structural equation model for a broader explanation.

REFERENCES

- Afdhal, Y., Suryadi, & Soefijanti, T. A. (2020). Pengaruh motivasi berprestasi dan stres terhadap prestasi akademik mahasiswa tahap akademik kelas internasional program studi pendidikan dan profesi dokter fakultas kedokteran Universitas Indonesia. *Improvement: Jurnal Ilmiah Untuk Peningkatan Mutu Manajemen Pendidikan*, 7(02), 100–110. <http://journal.unj.ac.id/unj/index.php/improvement/article/view/18366>
- Aini, I. I. Q., Santoso, D. B., & Indreswari, H. (2022). Hubungan Dukungan Sosial Orang Tua dengan Kejenuhan Belajar Selama Pembelajaran Daring di Sekolah Menengah Pertama Negeri. *Jurnal Pembelajaran, Bimbingan, Dan Pengelolaan Pendidikan*, 2(5), 410–421. <https://doi.org/10.17977/um065v2i52022p410-421>

- Alabbasi, A. M. A., Tadik, H., Acar, S., & Runco, M. A. (2021). Birth Order and Divergent Thinking: A Meta-Analysis. *Creativity Research Journal*, 33(4), 331–346. <https://doi.org/10.1080/10400419.2021.1913559>
- Alhadabi, A., & Karpinski, A. C. (2020). Grit, self-efficacy, achievement orientation goals, and academic performance in University students. *International Journal of Adolescence and Youth*, 25(1), 519–535. <https://doi.org/10.1080/02673843.2019.1679202>
- Anderman, E. M., & Patrick, H. (2012). *Achievement goal theory, conceptualization of ability/achievement, and achievement motivation*. In S. Christenson, A. Reschly, & C. Wylie (Eds.), *Handbook of Research on Student Engagement* (pp. 173-191). Springer. https://doi.org/10.1007/978-1-4614-2018-7_8
- Antshel, K. M., Parascandola, T., Taylor, L. E., & Faraone, S. V. (2021). Achievement goal orientation and stimulant misuse in college students. *Journal of American College Health*, 69(2), 125–133. <https://doi.org/10.1080/07448481.2019.1656635>
- Anwar, Z., Rahmawati, H., & Farida, I. A. (2022). Sukses akademik, motivasi dan perbedaan individu: studi literature review. *Empati – Jurnal Bimbingan Dan Konseling*, 9(2), 217–223.
- Ariani, D. W. (2022). How achievement goals affect students' well-being and the relationship model between achievement goals, academic self-efficacy and affect at school. *Journal of Applied Research in Higher Education*, 14(1), 111–134. <https://doi.org/10.1108/JARHE-08-2020-0273>
- Botzet, L. J., Rohrer, J. M., & Arslan, R. C. (2021). Analysing effects of birth order on intelligence, educational attainment, big five and risk aversion in an Indonesian sample. *European Journal of Personality*, 35(2), 234–248. <https://doi.org/10.1002/per.2285>
- Budiarto, D. A., & Setiowati, E. A. (2021). Motivasi Berprestasi ditinjau dari Dukungan Sosial dan Resiliensi pada Remaja dengan Orangtua Tunggal. *Jurnal Psikologi Terapan [JPT]*, 4(2), 82–92. <https://doi.org/https://doi.org/10.29103/jpt.v4i2.10204>
- Damian, R. I., & Roberts, B. W. (2015). Settling the debate on birth order and personality. *Proceedings of the National Academy of Sciences of the United States of America*, 112(46), 14119–14120. <https://doi.org/10.1073/pnas.1519064112>
- Deci, E. L., & Ryan, R. M. (2012). *Self-determination theory*. In P. A. M. Van Lange, A. W. Kruglanski, & E. T. Higgins (Eds.), *Handbook of Theories of Social Psychology: Volume 1* (pp. 416-436). SAGE Publications Ltd.
- Fadlelmula, F. K. (2010). Educational motivation and students' achievement goal orientations. *Procedia - Social and Behavioral Sciences*, 2(2), 859–863. <https://doi.org/10.1016/j.sbspro.2010.03.116>
- Fukuya, Y., Fujiwara, T., Isumi, A., Doi, S., & Ochi, M. (2021). Association of Birth Order With Mental Health Problems, Self-Esteem, Resilience, and Happiness Among Children: Results From A-CHILD Study. *Frontiers in Psychiatry*, 12(April). <https://doi.org/10.3389/fpsy.2021.638088>
- Frumos, F.-V., Leonte, R., & Candel, O. S. (2023). The Relationship Between University Students' Goal Orientation and Academic Achievement: The Mediating Role of Motivational Components and the Moderating Role of Achievement Emotions. *Frontiers in Psychology*, 14, 1296346. <https://doi.org/10.3389/fpsyg.2023.1296346>
- Goagoses, N., Itenge, H., Winschiers-Theophilus, H., & Koglin, U. (2021). The influence of social achievement goals on academic engagement: a cross-sectional survey in a Namibian primary school. *South African Journal of Psychology*, 51(3), 356–368. <https://doi.org/10.1177/0081246320957291>
- Gunadi, A., Santosa, M., Putra, G. M., & Erlangga, E. (2023). Hubungan antara stress akademik dan motivasi belajar terhadap prestasi belajar siswa SMP X. *Jurnal Pendidikan Dan Konseling*, 5(1), 5388–5394.
- Hulleman, C. S., Schrage, S. M., Bodmann, S. M., & Harackiewicz, J. M. (2010). A meta-analytic review of achievement goal measures: Different labels for the same constructs or different constructs with similar labels? *Psychological Bulletin*, 136(3), 422-449.

- Jamaludin. (2019). Uji Validitas, Struktur Internal, dan Measurement Invariance pada Alat Ukur Achievement Goal Orientation. *Jurnal Pengukuran Psikologi Dan Pendidikan Indonesia (JP3I)*, 8(2), 140–155. <https://doi.org/10.15408/jp3i.v8i2.13331>
- Lakshmi, A. R., & Arora, M. (2006). Promoting achievement orientation among adolescents: Role of parental behaviours. In *Psychological Studies* (Vol. 51, pp. 228–231). Psychological Studies.
- Lutfiwati, S. (2020). Motivasi Belajar Dan Prestasi Akademik. *Jurnal Kependidikan Islam*, 10(1), 54–63. <http://ejournal.radenintan.ac.id/index.php/idaroh>
- Natalya, L. (2018). Validation of Academic Motivation Scale: Short Indonesian Language Version. *ANIMA Indonesian Psychological Journal*, 34(1), 43–53. <https://doi.org/10.24123/aipj.v34i1.2025>
- Pasaribu, W., & Bowo, T. A. (2022). Korelasi Dukungan Sosial Orangtua dan Berpikir Positif dengan Kecemasan Siswa Menghadapi Ujian Nasional. *Jurnal Pendidikan Dan Konseling*, 4(6), 162–172.
- Puspita, B. K., & Kumalasari, D. (2022). Prokrastinasi dan Stres Akademik Mahasiswa. *Jurnal Penelitian Psikologi*, 13(2), 79–87. <https://doi.org/10.29080/jpp.v13i2.818>
- Puspitasari, D. (2021). Hubungan Peran Orang Tua dengan Motivasi Akademik Siswa. *Jurnal Pembelajaran, Bimbingan, Dan Pengelolaan Pendidikan*, 1(10), 855–860. <https://doi.org/10.17977/um065v1i102021p855-860>
- Putri, T. N., & Saleh, A. Y. (2020). Effects of Achievement Goal Orientation Types on Subjective Well-being. *Psychological Research on Urban Society*, 3(2), 65. <https://doi.org/10.7454/proust.v3i2.62>
- Quílez-Robres, A., Moyano, N., & Cortés-Pascual, A. (2021). Motivational, Emotional, and Social Factors Explain Academic Achievement in Children Aged 6–12 Years: A Meta-Analysis. *Education Sciences*, 11(9), 513. <https://doi.org/10.3390/educsci11090513>
- Rakhmaniar, A. (2021). Hubungan Komunikasi Interpersonal Orang Tua Dan Anak Dengan Motivasi Dan Prestasi Pada Pembelajaran Jarak Jauh Di Paud Arvardia. *Paradigma POLISTAAT: Jurnal Ilmu Sosial Dan Ilmu Politik*, 4(2), 121–138. <https://doi.org/10.23969/paradigmapolistaat.v4i2.3495>
- Rizki, M. A., & Sulastri, S. (2021). Pengaruh motivasi belajar, self esteem dan social support terhadap prestasi akademik mahasiswa S1 Pendidikan Akuntansi Universitas Negeri Malang angkatan 2015. *Jurnal Ekonomi, Bisnis Dan Pendidikan*, 1(2), 183–189. <https://doi.org/10.17977/um066v1i22021p183-189>
- Ryan, R. M., & Deci, E. L. (2017). *Self-Determination Theory: Basic Psychological Needs in Motivation, Development, and Wellness*. Guilford Press.
- Ryan, R. M., & Deci, E. L. (2020). Intrinsic and Extrinsic Motivation from a Self-Determination Theory Perspective: Definitions, Theory, Practices, and Future Directions. *Contemporary Educational Psychology*, 61, 101860. <https://doi.org/10.1016/j.cedpsych.2020.101860>
- Salsabila, S., & Muammaroh, N. L. R. (2022). Pengaruh Dukungan Sosial Orang Tua Terhadap Motivasi Belajar Santri Di TPQ Raudlatut Tholibin. *Psikodinamika - Jurnal Literasi Psikologi*, 2(2), 122–130. <https://doi.org/10.36636/psikodinamika.v2i2.976>
- Saputra, D., & Daliman, D. (2021). Parental Social Support and Achievement Motivation on Self-Regulated Learning Strategy with an Interest as a Mediator Variable. *JPI (Jurnal Pendidikan Indonesia)*, 10(3), 581. <https://doi.org/10.23887/jpi-undiksha.v10i3.29567>
- Schunk, D. H., Pintrich, P. R., & Meece, J. L. (2014). *Motivation in Education: Theory, Research, and Applications (4th ed.)*. Pearson.
- Senko, C., Durik, A. M., Patel, L., Lovejoy, C. M., & Valentiner, D. (2011). Performance-approach goal effects on achievement under low versus high challenge conditions. *Learning and Instruction*, 21(5), 467–477. <https://doi.org/10.1016/j.learninstruc.2010.06.001>
- Sulistiani, W., Fajrianti, F., & Kristiana, I. F. (2022). Validation of the Indonesian Version of the Multidimensional Scale of Perceived Social Support (MSPSS): A Rasch Model Approach. *Jurnal Psikologi*, 21(1), 89–103. <https://doi.org/10.14710/jp.21.1.89-103>

- Supriyadi, D. (2022). The Influence of Family Support on Students' Academic Motivation in Islamic High Schools. *Journal of Educational Research*, 35(2), 145-158.
- Tuominen, H., Niemivirta, M., Lonka, K., & Salmela-Aro, K. (2020). Motivation across a transition: Changes in achievement goal orientations and academic well-being from elementary to secondary school. *Learning and Individual Differences*, 79(January), 101854. <https://doi.org/10.1016/j.lindif.2020.101854>
- Uyun, M. (2022). Dukungan sosial teman sebaya dan persepsi siswa terhadap cara mengajar guru dengan motivasi belajar. *Edukasi Islami: Jurnal Pendidikan Islam*, 11(1), 753–777. <https://doi.org/10.30868/ei.v11i01.2335>
- Wentzel, K. R., & Muenks, K. (2016). Peer Influence on Students' Motivation, Academic Achievement, and Social Behavior. In K. R. Wentzel & G. B. Ramani (Eds.), *Handbook of Social Influences in School Contexts: Social-Emotional, Motivation, and Cognitive Outcomes* (pp. 13-30). Routledge.
- Yani, N., & Aulia, F. (2020). Peran Gender Dalam Menentukan Motivasi Akademik (Sebuah Tinjauan Literatur). *Jurnal Riset Psikologi*, 2020(4), 1–12.
- Zalika, R. D. Z., & Rusmawati, D. (2022). Hubungan Antara Dukungan Sosial Teman Sebaya Dengan Penyesuaian Diri Siswa Pondok Pesantren Kelas X Ma Ribatul Muta'Allimin Pekalongan. *Jurnal EMPATI*, 11(2), 72–79. <https://doi.org/10.14710/empati.2022.3>